

Call for Nomination for the Tokamak Assembly Contracts TAC1 and TAC2

PROCUREMENT SUMMARY

1 Introduction

The Call for Nomination subject of the present document is the first step of the Procurement Process leading to the execution of two installation works contracts, called “Tokamak Assembly Contract No. 01 - TAC1” and “Tokamak Assembly Contract No. 02 - TAC2”, also called “Contract(s)” in this document.

The purpose of this document is to provide a summary description of the Contracts, in terms of scope and program of works, required competences and contractual provisions, and to present the Procurement Process.

The Domestic Agencies are invited to nominate companies, institutions or other entities that are capable of providing works and associated supplies and services for TAC1 and/or TAC2 Contracts.

2 Background

2.1 The ITER Project

For a complete description of the ITER Project, covering both organizational and technical aspects of the Project, visit www.iter.org.

2.2 The ITER Facility, Tokamak and Assembly Plan

See sections 3 and 4 of the document *Technical Summary for the TAC-1 / TAC-2 Tokamak Assembly Contracts* ref. ITER_D_T7AWGL v1.2 available in Annex 1.

2.3 The ITER Procurement Strategy for Assembly and Installation

The document *ITER Procurement Strategy for Assembly and Installation* ref. ITER_D_UG4W5S v1.0 available in Annex 2 describes the main principles of ITER Procurement Strategy for Assembly and Installation.

The procurement strategy for the Tokamak Assembly (Worksite 1) as described in section 5 of ITER_D_UG4W5S document is confirmed with some adjustments on the scope of each Tokamak Assembly Contract (see section 3 of the present document); and considering the following correspondences:

- TAC1 corresponds to “Contract 2”,
- TAC2 corresponds to “Contract 1”,
- Contract for in-vessel components assembly and later works of Assembly Phase II is called TAC3.

As mentioned in ITER_D_UG4W5S document the award of TAC3 will be subject to a competition launched between both Contractors of TAC1 and TAC2.

3 Scope of the Contracts

See section 5 of Annex 1.

The scope of each Contract TAC1 and TAC2 will be further detailed at a later stage of the Procurement Process.

4 Required Competences

See section 6 of Annex 1.

5 Contractual provisions

5.1 Contracts Type

For both TAC1 and TAC2 Contracts, the type of contract will be Works Contract based on a Bill of Quantities, a Schedule of Unit Rates and an estimated Program of Works (volume and time schedule).

Each Contract will be broken down into phases with maximum amount per phase, and the Works will be confirmed, detailed and assigned progressively to the Contractor via Work Packages.

Each Contract will start with a preparation period in order to ensure a common thorough understanding of the technical and management requirements and constraints, to set-up a solid integrated organization and associated Contract implementation processes and procedures, and hence to secure the full speed of assembly operations.

The terms and conditions of the Contracts may include provisions from the “Conditions of Contract for Construction” (for building and engineering works designed by the Employer) also called “FIDIC RED BOOK Edition 1999” published by the Fédération Internationale des Ingénieurs-Conseils (FIDIC Copies of the Red Book can be obtained directly from the FIDIC web site fidic.org/bookshop).

The IO has appointed the MOMENTUM SNC (Joint Venture) as their Construction Management-as-Agent (CMA) contractor in charge of coordinating and supervising the site works. The CMA will also be appointed to undertake the role of the Engineer (as described in the FIDIC Red Book) or equivalent for the administration of these 2 Contracts.

5.2 Nuclear Liability

The ITER Organization is the nuclear operator of the ITER nuclear fusion facility (INB 174) under French nuclear law. However, unlike other nuclear operators of nuclear fission installations in France, nuclear fusion installations are not covered by the Paris Convention on nuclear third party liability for the time being. Pending negotiations with the Contracting parties to the Paris Convention, the special nuclear liability regime (i.e. limited strict liability of the nuclear operator) implemented by the Paris Convention does not apply.

Therefore, the ITER Council, by a decision of 2009 endorsed that until a solution is found, the ITER Organization may assume this responsibility by providing a declaration and waiver of indemnity regarding nuclear liability to indemnify suppliers of the IO and their subcontractors in case they are held liable, based on the principles of the Paris convention, this in the understanding that if no regulatory solutions could be found before nuclear operations of the ITER facility started, a proper mechanism would be established by the ITER Members in accordance with Article 15 of the ITER Agreement.

This declaration and waiver of indemnity regarding nuclear liability will be included in the Contracts signed by the Contractors and the IO.

5.3 CEAR Insurance

The ITER Organization and Fusion for Energy (the European Domestic Agency responsible for providing buildings to the ITER Organization) have taken out an insurance policy to cover:

- the risk of physical loss or material damage to the Project arising from whatsoever cause except if excluded,
- as well as to cover all sums which the Insured shall become legally liable to pay in respect of or arising from accidental bodily injury to or illness of third parties and accidental loss or damage or destruction to property belonging to third parties occurring during the construction/erection period on the construction site and arising from or in connection with the Insured Project unless excluded (CEAR Insurance Policy).

Contractors, Subcontractors of any tier and suppliers and/or consultants (in respect of their site activities) are also covered by this insurance policy and as such are only liable for the deductible, the exclusions or above the limit of coverage mentioned in the insurance policy in accordance with the insurance certificate that will be provided during the next phase of the tender process.

This insurance policy carries a global aggregate coverage limit of Euro 1,000,000 000 (one billion Euro).

The ITER Organization and Fusion for Energy will cover their own buildings used by the Contractors to perform their duty on Site, excluding the content being the contractor's property.

The CEAR insurance policy subscribed by the ITER Organization and Fusion for Energy shall not affect the contractor's liabilities or obligations.

6 Procurement Process

The Procurement Process starting with the present Call for Nomination aims at signing two installation works contracts called “Tokamak Assembly Contract No. 01 - TAC1” and “Tokamak Assembly Contract No. 02 - TAC2” with two different Tenderers.

6.1 Procurement Procedure

The Procurement Procedure selected for the award of the two Contracts is the *Call for Tender* procedure.

The Call for Tender procedure is composed of the following steps:

➤ Stage 1- Call for Nomination (CFN):

The Call for Nomination is the first stage of the Call for Tender process. The IO formally invites the Domestic Agencies to nominate potential candidates that are capable of providing the required supplies, services or works in order to enable the IO to pre-qualify the nominated companies.

➤ Stage 2 - Pre-Qualification (PQ):

Following the Call for Nomination, the Pre-Qualification ensures that offers are sought only from qualified Candidates who have the requisite capacity and experience to satisfactorily perform the intended work. The aim of the Pre-Qualification is to establish a list of qualified Candidates (Consortium or single entity) based on the set of selection criteria.

➤ Stage 3 - Invitation to Tender (IT):

Following the Call for Nomination and/or the Pre-Qualification stages, the Invitation to Tender stage is used to obtain proposals from qualified Candidates identified as potential Tenderers.

At Stage 1 (CFN), subject of the present document, nominations are sought from ITER Domestic Agencies for companies, institutions or other entities that are capable of providing works and associated supplies and services for TAC1 and/or TAC2 Contracts without distinction.

At Stage 2 (PQ), the Candidates shall decide to apply to TAC1, or TAC2, or both TAC1 and TAC2.

At Stage 3 (IT), the qualified Candidates shall decide to bid on TAC1, or TAC2, or both TAC 1 and TAC2, in line with their Pre-qualification applications, and being aware that the two Contracts will be awarded to two different Tenderers.

6.2 Procurement Process Timetable

The tentative timetable is as follows (for both TAC1 and TAC2):

Milestone	Date
Call for Nomination	July 2017
Invitation for Pre-qualification Applications	August 2017
Pre-qualification Applications Submission	October 2017
Invitation to Tender	December 2017
Tender Submission	April 2018
Contract Award	Q3 2018
Commencement Date	Q4 2018
Start of Site Works	Q1 2019

The estimated duration of the contract is 6 years.

6.3 Candidature

Participation is open to all legal persons participating either individually or in a grouping (consortium) which is established in an ITER Member State. A legal person cannot participate individually or as a consortium partner in more than one application or tender of the same contract. A consortium may be a permanent, legally-established grouping or a grouping, which has been constituted informally for a specific tender procedure. All members of a consortium (i.e. the leader and all other members) are jointly and severally liable to the ITER Organization.

The consortium grouping shall be presented at the Pre-Qualification stage. The Candidate's composition cannot be modified without the approval of the ITER Organization after the Pre-Qualification.

In order for a consortium to be acceptable, the individual legal persons included therein shall have nominated a leader with authority to bind each member of the consortium, and this leader shall be authorised to incur liabilities and receive instructions for and on behalf of each member of the consortium. Evidence of such authorisation shall be submitted with the Pre-qualification Application and the Tender in the form of power of attorney signed by legally authorised signatories of all the members.

6.4 Contracting Rules

Below mentioned restrictions apply to Parent Companies as well as to subsidiaries.

By "Parent Companies", it is meant a firm that owns or controls other firms (called subsidiaries) which are legal entities in their own right. IO will consider as a subsidiary a

company controlled by another (the parent) through the ownership of greater than 50 percent of its voting stock. This basically represents 50% + 1 vote.

Voting Stocks (or voting shares) are the ordinary shares the ownership of which gives an entity the right to vote in the issuing firm's annual general meeting. The ultimate and exclusive right conferred by a lawful claim or title, and subject to certain restrictions to enjoy, occupy, possess, rent, sell, use, give away, or even destroy an item of property.

Parent Companies can be a holding company. In that particular case, and in order to simplify the implementation of this principle for holding companies, which definition can vary with the legal system, the IO will retain the same definition as for Parent Companies (> 50% of voting shares).

6.4.1 Overall Contracting Rules

Considering the Worksites and works contracts as presented in Annex 2, a company or a consortium may tender for multiple contracts, but shall be awarded maximum one contract for Worksite 1 (Tokamak Assembly), one contract for Worksite 2 (Tokamak Complex) and no more than three contracts for Worksites 3 to 5 (Plant Installation in Balance of Plant). This rule applies to any company, any consortium member and any sub-contractor.

For Worksite 1 and Worksite 2, two contractors are considered for each Worksite. A company awarded for a contract of one Worksite as single entity, consortium member or sub-contractor cannot be awarded for the second contract of the same Worksite, but can be awarded for a contract of the other Worksite whatever the form of participation. For sub-contractors, exceptions may be granted for very specific activities which will be identified by the IO, if any, at Pre-qualification stage.

6.4.2 Worksite 1

According to the previous provisions, TAC1 and TAC2 Contracts will be awarded to two different contractors, composed of different companies with possible few exceptions for sub-contracting stated by the IO in the Pre-qualification documentation.

Companies are allowed to bid on both TAC1 and TAC2 Contracts. But a company awarded a Contract (TAC1 or TAC2) will be prevented being awarded the other Contract (TAC2 or TAC1).

6.4.3 Sub-contracting Rules

All sub-contractors who will be taken on by the Contractor shall be declared with the tender submission. Each sub-contractor will be required to complete and sign forms including technical and administrative information which shall be submitted to the IO by the tenderer as part of its tender. The IO reserves the right to approve any sub-contractor which was not notified in the tender and request a copy of the sub-contracting agreement between the tenderer and its sub-contractor(s).

For each Contract, sub-contracting is allowed but it is limited to one level, and its cumulated volume is limited to 30% of the total Contract value.

Two levels of sub-contracting may be considered for very specific activities which will be mentioned by the IO in the Pre-qualification documentation.

At Pre-qualification stage, the capacity of sub-contractors may be considered for special cases duly mentioned in the Pre-qualification documentation. In that case, a letter of intention will be required for the sub-contractors.

6.4.4 Particular conflict of interest situation

Any company (consortium, members, sub-contractors and their experts) who participates in the preparation of the procurement documents or otherwise is involved in or works on any other information relevant to this Procurement Procedure is neither allowed to participate in this Procurement Process nor allowed to participate in the resulting TAC1 and TAC2 Contracts.

This rule is applicable but not limited to any company involved in the following IO contracts (as single entity, consortium member or sub-contractor):

- Construction Management-as-Agent Service Contract – ref. IO/16/CT/4300001334 , whatever the scope of services of the company in this contract;
- Project Management Services Contracts ref. IO/16/CT/4300001402 and IO/16/CT/4300001414, whatever the scope of services of the company in these contracts;
- Alignment and Metrology Support Contracts ref. ITER/CT/6000000142, ITER/CT/6000000144 and ITER/CT/6000000146, if the company is assigned services related to TAC1 or TAC2 scope of works.

7 Annexes

Annex 1:

Technical Summary for the TAC-1 / TAC-2 Tokamak Assembly Contracts

Ref. ITER_D_T7AWGL v1.2

Annex 2:

ITER Procurement Strategy for Assembly and Installation

Ref. ITER_D_UG4W5S v1.0

Call for Nominations for Tokamak Assembly Contracts TAC1
and TAC2

Annex I

**Technical Summary for the TAC-1 / TAC-2 Tokamak
Assembly Contracts**

Ref. ITER_D_T7AWGL v1.2

Technical Specifications (In-Cash Procurement)

Technical Summary for the TAC-1 / TAC-2 Tokamak Assembly Contracts

This document provides a high level definition of the scope of works for the Tokamak Assembly Works (TAW). Described are the overall configuration of the Tokamak device in terms of its major components, sub-systems and systems, and the technologies involved in their design and construction. Also summarised are the scope of the two planned Tokamak Assembly Contracts (TACs), and the essential expertise, experience and skills required of the performing Contractors.

Table of Contents

1	PURPOSE	3
2	ABBREVIATIONS	3
3	TECHNICAL DESCRIPTION	5
3.1	THE ITER PROJECT	5
3.1.1	<i>Staged Project Delivery</i>	5
3.1.2	<i>Contracting Plan</i>	5
3.2	THE ITER FACILITY	5
3.3	THE ITER TOKAMAK AND ASSEMBLY PHASE 1 SCOPE	6
3.3.1	<i>Major Tokamak Systems</i>	7
3.3.1.1	Vacuum Vessel	7
3.3.1.2	Magnet Systems	8
3.3.1.3	Thermal Shield	10
3.3.1.4	Cryostat	10
3.3.1.5	In-Vessel Systems	12
3.3.1.6	Diagnostic Systems	13
3.3.1.7	Heating and Current Drive Systems	14
3.3.2	<i>Service and Other Systems</i>	16
3.3.2.1	Tokamak Cooling Water System	16
3.3.2.2	Vacuum System	17
3.3.2.3	Cable Trays and Instrumentation	18
3.3.2.4	Fuelling and Wall Conditioning Systems	18
4	ASSEMBLY PROCESS	18
4.1	ASSEMBLY FACILITIES AND TOOLS	20
5	SCOPE OF THE CONTRACTS	20
5.1	PHYSICAL SCOPE	20
5.2	SCOPE BOUNDARIES	20
5.3	SCOPE OF WORK	21
6	REQUIRED COMPETENCES	21
6.1	ASSEMBLY TOOLING	22
6.2	CLEAN CONDITIONS WORKING	22
6.3	CODES AND STANDARDS	23
6.4	HIGH VACUUM AND UHV	23
6.5	OCCUPATIONAL SAFETY	23
6.6	PRECISION ASSEMBLY OF LARGE AND COMPLEX MECHANICAL SYSTEMS	23
6.7	PROCESS DEVELOPMENT AND QUALIFICATION	24
6.8	QUALITY ASSURANCE / QUALITY CONTROL	24

6.9	REGULATED CONSTRUCTION	24
6.10	WELDING	24
6.11	CLEAN CONDITIONS SCAFFOLDING	25
6.12	CLEANING	25
6.13	INSPECTION AND NON-DESTRUCTIVE EXAMINATION	25
6.14	INSTRUMENTATION INSTALLATION	25
6.15	LARGE VOLUME OPTICAL METROLOGY	26
6.16	LIFTING AND HANDLING	26
6.17	REVERSE ENGINEERING, CUSTOMISATION AND PRECISION MACHINING, WORKSHOP	26
6.18	TOOLING MAINTENANCE, STORAGE AND PRESERVATION	27

1 Purpose

The purpose of this document is to provide a high level definition of the scope of works and required Contractor competences for the Tokamak Assembly Works (TAW).

The document describes the overall configuration of the Tokamak device in terms of its major components, sub-systems and systems, and elaborates the technologies involved in their design and construction. The document also summarises the scope of the two planned Tokamak Assembly Contracts (TACs), details the essential expertise, experience and skills required of the performing Contractors, and provides a brief description of the works organisation.

2 Abbreviations

The following table lists and defines the abbreviations used in this document.

Abbreviation	Definition
ASN	Autorité de Sûreté Nucléaire
B17	Building 17, Cleaning Facility
CC	Correction Coil
CCP	Cryostat Cryo-Pump
CCWS-1	Component Cooling Water System (Loop) 1
CDSW	Capacitor Discharge Stud Welding
CHWS	Chilled Water System
CMA	Construction Management as Agent
CS	Central Solenoid
CTS	Cryostat Thermal Shield
CVB	Cold Valve Box
CWP	Construction Work Package
DMS	Disruption Mitigation System
DR	Draining and Refilling
DRS	Divertor Replacement Structure
EC	Electron Cyclotron
ECTS	Equatorial Cryostat Thermal Shield
ELM	Edge Localised Mode (Coil)
EQ	Equatorial
ESPN	Equipements Sous Pression Nucléaire
FPPS	First Plasma Protection Systems
FW	First Wall
GDC	Glow Discharge Cleaning system
GIS	Gas Introduction System
H&CD	Heating and Current Drive
IBED	Integrated Blanket, ELM-VS, and Divertor (Loop)
IC	Ion Cyclotron
INB	Installation Nucléaire de Base (Basic Nuclear Installation)

IO	ITER Organization
IWP	Installation Work Package
LCTS	Lower Cryostat Thermal Shield
LH	Lower Hybrid
LPC	Lower Pipe Chase
LWR	Lower
MI	Mineral Insulated
NBI	Neutral Beam Injector
PF	Poloidal Field
PHTS	Primary Heat Transfer System
PIA	Protection Important Activities
PIS	Pellet Injection System
RF	Radio Frequency
SB	Shielding Blanket
SQEP	Suitably Qualified and Experienced Personnel
STS	Support Thermal Shield
TAC	Tokamak Assembly Contract
TAW	Tokamak Assembly Works
TCC	Tokamak Complex Contract
TCP	Torus Cryo-Pump
TCPH	Torus Cryo-Pump Housing
TCWS	Tokamak Cooling Water System
TF	Toroidal Field
TFGS	Toroidal Field (Coil) Gravity Support
TIG	Tungsten Inert Gas
TL	Temporary Limiter
TS	Thermal Shield
UCTS	Upper Cryostat Thermal Shield
UHV	Ultra-High Vacuum
UPC	Upper Pipe Chase
UPR	Upper
VACB	Valve Actuator Control Box
VS	Vertical Stability (Coil)
VV	Vacuum Vessel
VVTS	Vacuum Vessel Thermal Shield

Table 1: Abbreviations and Acronyms

For a complete list of ITER abbreviations see: ITER_D_2MU6W5 - ITER Abbreviations.

3 Technical Description

3.1 The ITER Project

For a complete description of the ITER Project, covering both organizational and technical aspects of the Project, visit www.iter.org.

3.1.1 Staged Project Delivery

A four stage roadmap to Fusion Power operations is planned to reduce technical risk, facilitate the earliest possible First Plasma, and to align the programme and funding. This plan separates assembly of the Tokamak into four distinct phases; the timeline for the first two Tokamak Assembly Phases is shown in Figure 1.

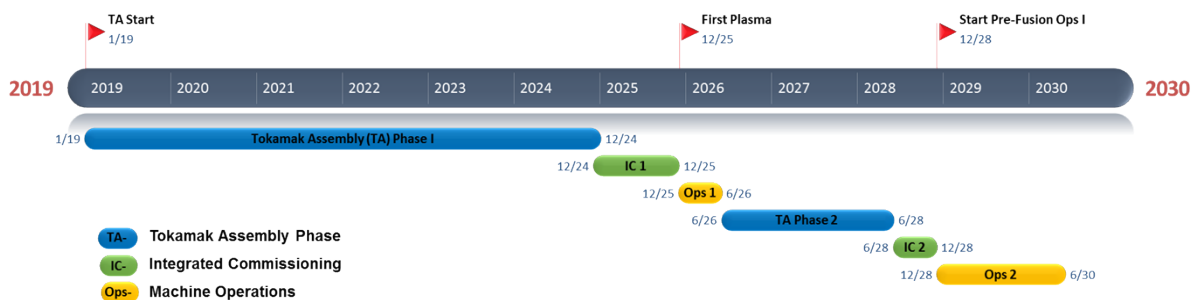

Figure 1. Roadmap to Fusion Power – Assembly Phases 1 and 2

- **Assembly Phase 1** includes the basic Tokamak machine with systems essential for First Plasma operation; the installations comprise permanent hardware, temporary equipment replacing permanent hardware, such as the main in-vessel components, and captive components that cannot be installed in later assembly phases.
- **Assembly Phase 2** includes the installation of the main in-vessel components, including the Blanket, the Divertor and ELM coils. EC and NBI heating systems will be installed and diagnostics systems will be added to support the research program. Preparatory activities for Assembly Phase 2 will occur during Assembly Phase 1.

3.1.2 Contracting Plan

IO plans to award two Contracts at this time, TAC-1 and TAC-2, to cover the main Phase 1 Tokamak Assembly Works; the scope of these Contracts is predominately mechanical assembly and installation.

To complete the Phase 1 and Phase 2 Tokamak assembly scope, a further TAC Contract (TAC-3) covering the in-vessel assembly and installation activities, and Phase 2 installation.

3.2 The ITER Facility

The ITER Facility is currently under construction in Cadarache, Southern France.

Central to the facility is the Tokamak Complex, a nuclear rated structure in reinforced concrete that comprises three integrated buildings, Figure 2. The Complex has a footprint of 118 x 81 m, extends vertically from -15 m to +40 m relative to ground level, and contains the plant systems that service (power, heat, cool, condition, fuel, monitor and control) the Tokamak.

To support the assembly of the Tokamak machine there is a steel-framed Assembly Building and Cleaning Facility, arranged to form a continuous working space.

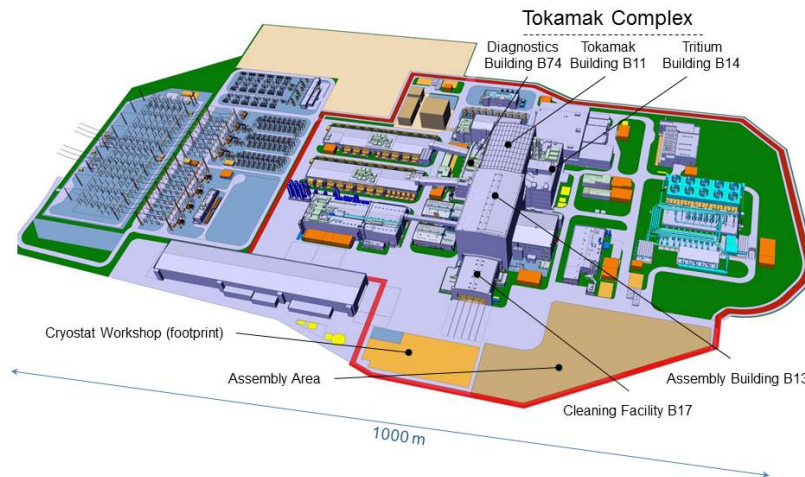

Figure 2: Layout of the ITER Site

3.3 The ITER Tokamak and Assembly Phase 1 scope

The major Tokamak systems are identified in Figure 3, and comprise a toroidal Vacuum Vessel (VV) and In-vessel components, four Superconducting Magnet Systems, and Thermal Shields (TS), all contained in, and structurally supported by a Cryostat.

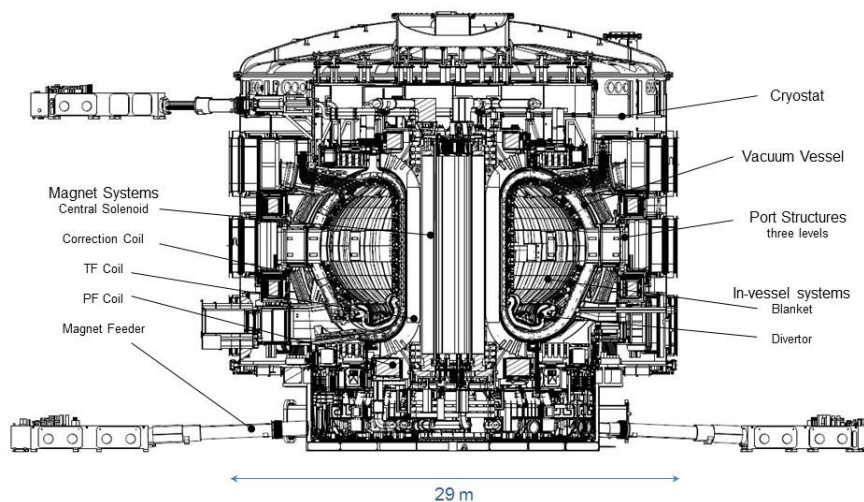

Figure 3: Major Tokamak Systems

The Tokamak is enveloped by a cylindrical concrete bio-shield of 30 m diameter and 30 m height, located at the centre of the Tokamak Building. The volume inside the bioshield is known as the Tokamak PIT, and at the lower level the civil structures include the massive support for the Tokamak machine, termed the Crown. Connections between the machine supports and components are made via steel plates embedded in the concrete; globally the Tokamak building complex is provided with about 100 000 embedded plates.

The bio-shield and the surrounding building structure support the Cryostat, and provide the radiation shielding.

3.3.1 Major Tokamak Systems

3.3.1.1 Vacuum Vessel

The VV, see Figure 4, is the primary confinement barrier for the radioactive inventory, and is categorised SIC-1, and ESPN. It is designed, constructed and tested in accordance with the French nuclear construction code RCC-MR. All handling, assembly and testing activities associated with the VV are designated Protection Important Activities (PIA), and subject to surveillance by ASN, see section 6.

The VV is a high integrity, double-walled structure in stainless steel that provides the Ultra-High Vacuum (UHV) environment necessary for Plasma operation, and features port structures at three levels to allow access for plasma heating, fuelling, vacuum pumping, diagnostics, and in-vessel component services. For handling, assembly and installation purposes, the VV is divided into nine, 40° toroidal sectors, of 12.3 x 6.6 x 6.7 m and ~440 t.

Each VV port is aligned with a penetration in the Cryostat and Bioshield and is equipped with large rectangular bellows that complete the Cryostat vacuum boundary, and accommodate relative movement between the two systems due to temperature differences and mechanical loads.

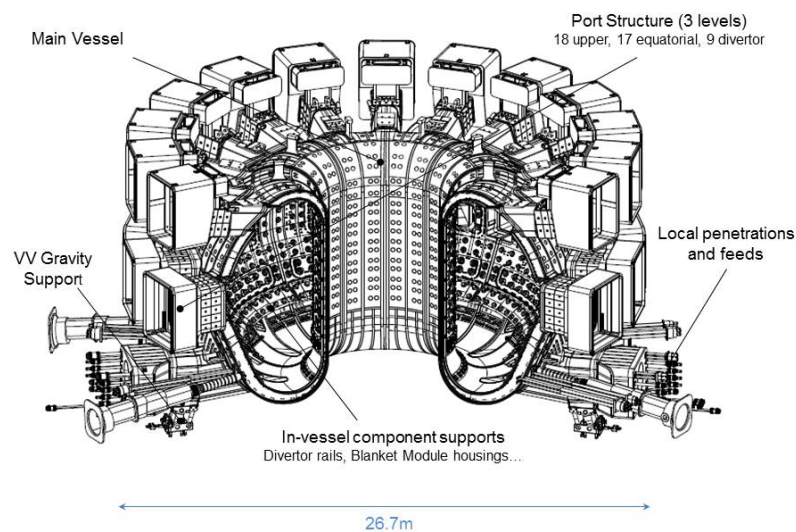

Figure 4: Vacuum Vessel and Port Structures

The interspace between the VV walls contains shielding blocks that reduce both neutron fluxes and radiation levels to the ex-Vessel Tokamak components. Water is circulated through the interspace to remove the heat deposited during plasma operation and maintain VV temperature, to bake the vessel to promote UHV conditions, and to remove decay heat loads.

The VV is supported via its nine lower ports to the Cryostat base using hinged supports that allow radial, but restrain toroidal movement.

The Phase 1 scope of work includes; installation of cable looms, cable trays, diagnostics and other hardware on the inner, outer and between the VV walls; integration (sub-assembly) of the main VV sectors; lifting, handling and positioning of the components.

The in-situ welding of the VV sectors and the port structures is the subject of a dedicated contract, and is out of scope of the TAC Contracts.

3.3.1.2 Magnet Systems

There are four superconducting magnet systems, see Figure 5; the Toroidal Field (TF) magnet, the Poloidal Field (PF) coils, the Central Solenoid (CS), and Correction Coils (CCs), plus the superconducting feeders that supply electrical power, helium cooling, and instrumentation for the magnets and their associated structural components. During operation the magnet system and associated structures are actively cooled to 4K.

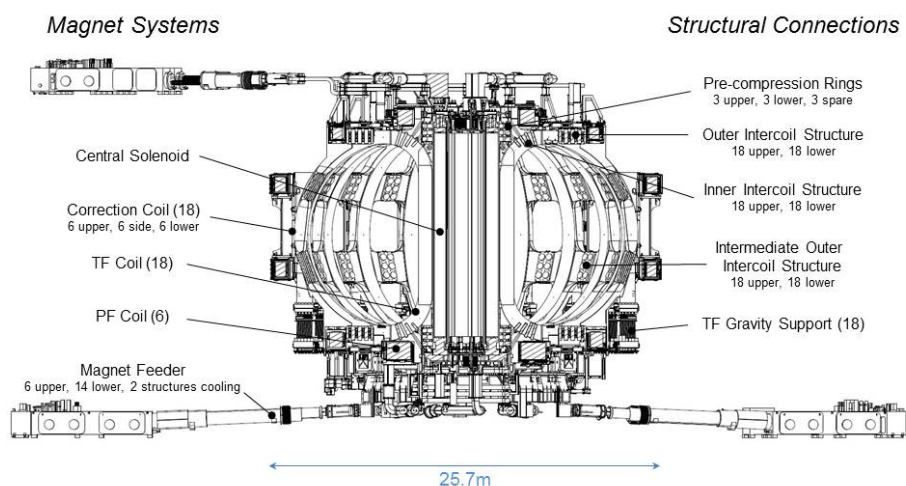

Figure 5: Magnet Systems

The TF magnet provides the toroidal magnetic field for confining the Plasma, and consists of 18 TF coils arranged in a toroidal array, and interconnected at four poloidal locations to form a structurally continuous assembly.

The inboard legs of the D-shaped TF coils are wedged over the full thickness and height of their side walls to resist the centring forces which exist during operation. In the bordering curved regions, arrays of solid shear keys resist out-of-plane forces. The wedging surfaces, including the regions surrounding the shear keys, must be accurately matched (customised) to achieve the required alignment, and reduce stress peaks in operation. The intercoil connections and shear keys also require customisation to ensure the required fit, and accommodate dimensional variations in the coils.

Component	Qty.	Dimensions (m)	Mass (t)
TF Coil	18	16.5 x 9.2 x 3.7	312
PF1	1	Ø 9.8 x 1.8	193
PF2	1	Ø 18.2 x 1.3	208
PF3	1	Ø 26.7 x 1.5	386
PF4	1	Ø 26.5 x 1.5	359
PF5	1	Ø 18.6 x 1.5	315
PF6	1	Ø 11.1 x 1.5	384
Central Solenoid	1	Ø 4.3 x 16.6	1000

Table 2: Major magnet components - dimensions and weights

The TF coils are the main structural components of the magnet system, and provide support to the other magnets.

Six circular PF coils are located around (above, below and radially outboard) the TF magnet with their axes vertical. The PF coils are attached to the TF magnet via supports that allow differential radial expansion using sliding joints or flexible plates; the supports are customised on assembly to ensure alignment and function.

The CS is a stack of six independent, circular coils (modules) that are connected structurally, and pre-compressed via tie-plates located around the perimeter and bore of the coil stack. The CS is located inside the central vault formed by the inner legs of the TF coils, and supported via a customised flexible structure, connected to the base of the TF inner legs.

The CS will be assembled in a dedicated workstation in the assembly building, and installed as a single component.

The PF coils and CS together initiate, shape and position the Plasma, and generate and maintain the Plasma current.

Eighteen CCs, arranged in three toroidal arrays of 6 six coils each, are located above, below and outboard of the TF magnet and are connected to the TF coil cases with specific, customisable clamping supports. The side CC is the largest of these coils at 7.2 x 7.1 x 0.9 m, and has a mass of 4.6 t.

The CCs compensate for errors in the Toroidal Magnetic Field due to asymmetries in the Tokamak design, geometric variations that arise during assembly, and the influence of magnetic materials.

The Magnet systems are supported via 18 flexible support columns, termed **TF Gravity Supports** (TFGS) that connect the leg integral to the outboard / lower region of the TF coils to the Cryostat base. The TFGS are custom shimmed at their upper and lower extremities to ensure alignment and function.

The magnets are provided with electrical power and cryogenic coolant, and are instrumented via **feeders** located in upper and lower regions of the Tokamak. These feeders enter/exit the Cryostat via dedicated feedthroughs in the Cryostat wall.

The Phase 1 scope of work covers all of the installation activities on the superconducting magnet systems. These activities include installations IO has designated “specialised works”, insofar as they present particular technical challenges and risks, and require specific technological knowledge and dedicated, purpose-built equipment. For the specialised works,

IO will provide pre-qualified assembly procedures and any associated, purpose-built equipment, and will qualify the performing TAC Contractor.

3.3.1.3 Thermal Shield

The purpose of the TS, see Figure 6, located between the cold superconducting magnets and the warm Tokamak components (e.g. the Cryostat and VV), is to reduce radiative heat transfer to the cold (superconducting magnet) mass to limit the demand for 4K helium, and the installed capacity of the helium plant.

The TS is a single wall structure in 304LN stainless steel, silver plated to reduce thermal emissivity, and cooled with 80K helium. It is designed and fabricated in accordance with the dedicated ITER TS code based on ASME and EN Codes.

Driven by the overall assembly sequence for the Tokamak, the TS is sub-divided into two main systems:

- Vacuum Vessel Thermal Shield (VVTS), comprising:
 - 9 x 40° VVTS sectors,
 - Port Shrouds at three levels;
- Cryostat Thermal Shield (CTS), comprising:
 - Lower Cryostat Thermal Shield (LCTS),
 - Support Thermal Shield (STS),
 - Equatorial Cryostat Thermal Shield (ECTS),
 - Upper Cryostat Thermal Shield (UCTS).

The Phase 1 scope of work covers all of the installation activities on the thermal shield.

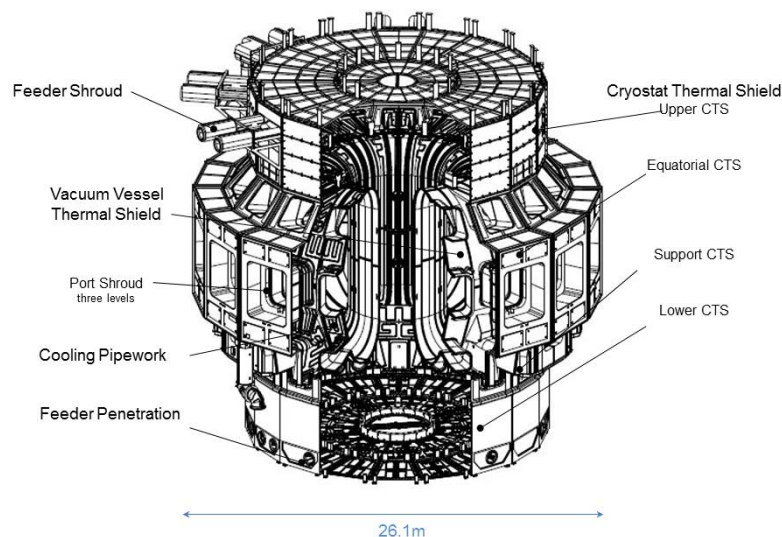

Figure 6: Thermal Shield

3.3.1.4 Cryostat

The purpose of the **Cryostat**, see Figure 7, the largest of the Tokamak components at 29m diameter and 29m height, is to provide a high vacuum environment to thermally insulate the

superconducting magnets and other in-cryostat components operating at cryogenic temperatures.

It contains and supports the Tokamak components, transferring their loads to the Tokamak building, and features penetrations for services to the in-cryostat components, and to access the VV ports.

The Cryostat is a fully welded structure in SS 304/304L, designed and constructed in accordance with ASME VIII, Div. 2.

For installation the Cryostat sections will be site fabricated into four large sections, as detailed in Table 3 and illustrated in Figure 7.

Component	Overall Dims. (m)	Mass (t)
Cryostat Base Section	Ø 29.3 x 6.0	1166
Cryostat Lower Cylinder	Ø 28.8 x 10.4	667
Cryostat Upper Cylinder	Ø 29.3 x 9.1	591
Cryostat Outer lid	Ø 29.3 x 4.3	703

Table 3: Dimensions and Weight of the Main Cryostat Sections

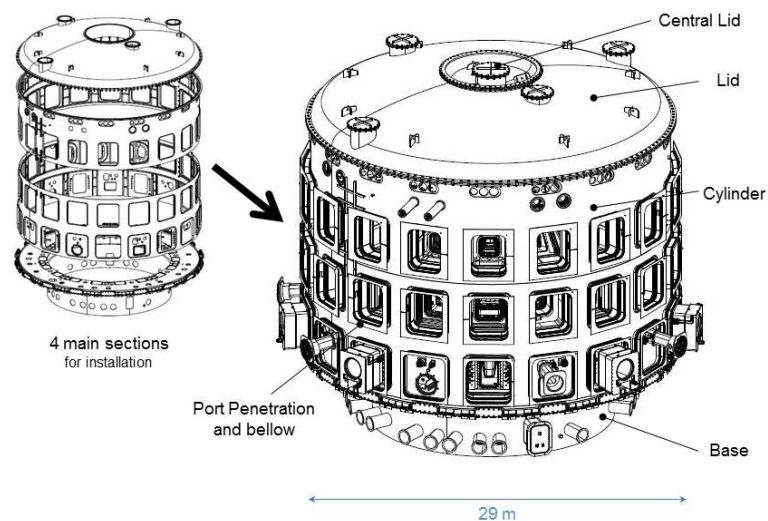

Figure 7: Cryostat

The Phase 1 scope of work includes: the final cleaning of the cryostat sections; lifting, placement and alignment of the sections within the bioshield pit; survey, customization and installation of the supports; and the installation of numerous penetrations and hardware.

The site fabrication of the large sections, the welding fit-up and joining (welding) of the sections in the pit is the subject of a separate contract, and is out of scope of the TAC Contracts.

3.3.1.5 In-Vessel Systems

The major in-vessel systems comprise the blanket, the divertor, the in-vessel coils and their respective coolant and power feeders, see Figure 8, together with the front end of the Diagnostics systems, section 3.3.1.6.

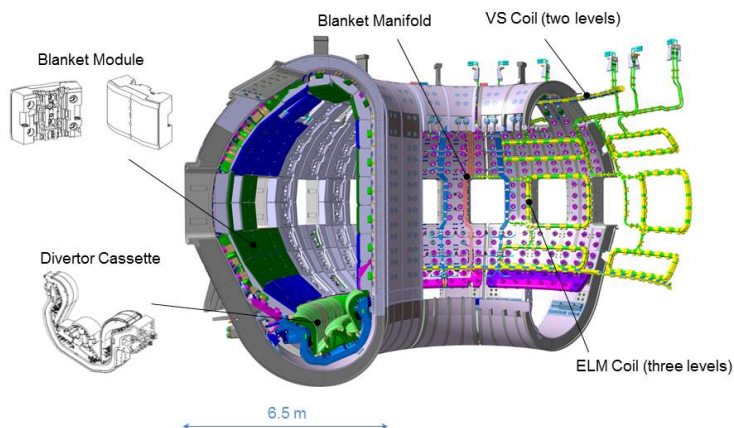

Figure 8: Vacuum Vessel and Permanent (Phase 2) In-vessel Systems

3.3.1.5.1 Blanket and Divertor

The blanket and divertor are among the most critical components in terms of design requirements and performance, and will be installed in assembly Phase 2 following the commissioning and initial operation of the Tokamak, see section 3.1.1.

For the initial operation period the VV, and the in-vessel components that must be installed in Phase 1, will be protected by temporary protection components, known as the First Plasma Protection Systems (FPPS), also installed in Phase 1. The FPPS comprise four Temporary Limiters (TL) and three Divertor Replacement Structures (DRS), see Figure 9.

The installation of the FPPS components in Phase 1, and the Blanket and Divertor in Phase 2 is out the scope of the TAC-1 and TAC-2 Contracts.

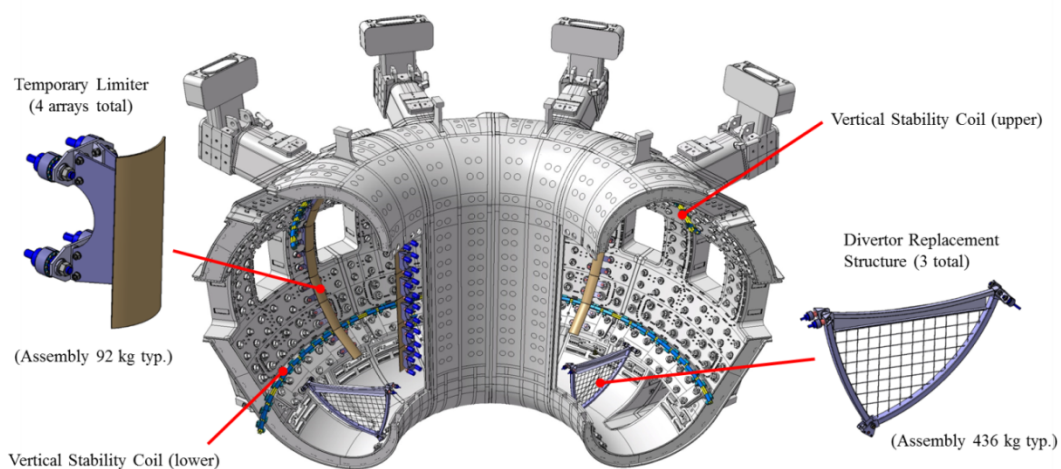

Figure 9: Phase 1 In-vessel Protection Systems

The **Temporary Limiter (TL)** is the largest and most highly loaded component of the First Plasma Protection Components. Consisting of four identical loops of 18 segments each (72 segments in total) the TL defines the main plasma boundary and prevents field lines and runaway electrons from damaging the VV in-vessel systems. Each limiter consists of type 316L steel components that are assembled in-vessel as small sub-components. Each limiter includes a curved steel tile that is roughly 1 m long by 0.4 m wide, which is supported by a steel structure of ~ 0.5 m height for a total weight of ~ 260 kg for each TL segment.

Three **Divertor Replacement Structures (DRS)** are located at the bottom of the VV, see Figure 9, and complete the poloidal loop created by the temporary limiters, with the role of protecting the bottom section of the VV. A bar spans from the inboard to outboard walls of the VV to provide a hard stop position against plasma displacements that might damage the lower areas of the VV. The DRS also integrates a mesh to interrupt the potential growth of small plasma filaments that may occur in the lower area of the VV.

3.3.1.5.2 In-vessel Coils

The water cooled in-vessel coils comprise a pair of Vertical Stability (VS) coils, located above and below the VV mid-plane, Figures 8 & 9, and 27 Edge Localised Mode (ELM) coils located at three levels, Figure 8. All coils are located between the blanket and VV wall.

The VS coils are to be wound in-situ and are installed in Phase 1, whereas the ELM coils are delivered as individual, complete components and are installed in Phase 2.

The in-vessel coil systems include their respective feeders supplying the electrical power and water cooling for operation.

The installation of the in-vessel coils is out of the scope of the TAC-1 and TAC-2 Contracts.

3.3.1.6 Diagnostic Systems

The Diagnostic Systems consist of instrumentation to measure plasma behaviour and performance that is relevant to the experimental study of the plasma. Some measurements are specifically needed for protection of the Tokamak machine and plasma control. This instrumentation has significant differences to conventional plant instrumentation, and so requires specialised skills for installation.

ITER requires approximately 70 diagnostic systems that utilise a variety of techniques to measure diverse physical phenomena such as magnetic, optical, microwave, x-ray, gamma rays, and neutron. A key requirement is that the diagnostics have to view or be in close proximity to the plasma –implying special requirements in the construction, materials, and assembly techniques, for example, radiation tolerance, thermal conductance, ultra-high vacuum compatibility, resistance to large electro-magnetic forces. Some systems are inaccessible after construction and these have very high reliability requirements.

The systems are situated in 3 main areas, see Figure 10:

- In-Vessel – mainly magnetic diagnostics, but also other discrete sensors totalling several thousand, together with the cabling system to transmit the signals. In total > 60 km of mineral insulated cabling, ~200 000 stud welded cable clips, and ~15 000 attachments welded to the VV are included. There are also some passive components attached to the blanket modules and first wall panels;
- Outside surface of the Vessel – mainly magnetic diagnostics, and cabling. One of the first Tokamak Assembly activities, the outer vessel systems are captive components.
- Port systems – consist of a port plug that faces the plasma, and equipment racks in the port cell that intercept and process the signal. The port plug (up to 45 t, 2 m x 2 m x 4 m) provides access to the plasma, but it also has a function for shielding, and cooling, and unusually for such a large structure, alignment is critical. The primary tasks for

installation are the handling of the components, alignment of the support rails, customisation and bolting/welding of the vacuum seal, and interconnection of system modules. The number of diagnostic plugs to be installed in the first two assembly phases is identified in Table 4.

Phase 1 scope of the TAC Contractors includes the installation of all diagnostics on the outside surface of the VV, the installation of part of the in-vessel diagnostics, and the port based systems associated with two equatorial port plugs. The connection of the diagnostics to the plant systems is outside the scope of the TAC Contracts.

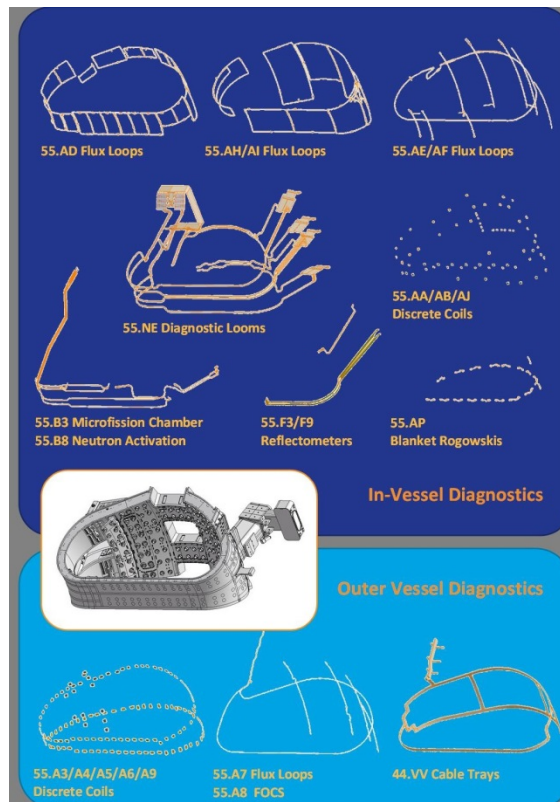

Figure 10. Overview of the In-vessel, and Outside Vessel Diagnostic Systems

3.3.1.7 Heating and Current Drive Systems

The Heating and Current Drive (H&CD) systems comprise; three Neutral Beam Injectors (NBI) i.e. two heating beam lines, and one combined heating and diagnostic beam line; and three Radio Frequency (RF) systems operating at the Electron Cyclotron (EC), Ion Cyclotron (IC) and Lower Hybrid (LH) frequencies.

3.3.1.7.1 Neutral Beam System

The NB System provides neutral beams for plasma heating and current drive, plasma rotation, fuelling, and plasma current, and density profile control, and the heating beams are also used to measure the magnetic fields in the plasma. In addition, the Diagnostic Neutral Beam System provides a dedicated neutral beam, for helium ash measurements, and allows localized measurement of various plasma parameters, such as ion temperature and impurity density.

The NB Injectors (NBIs) occupy the dedicated, two storey NB cell, located adjacent to the bioshield, on the North side of the Tokamak building, and utilising three, specialised equatorial ports on the Tokamak. The majority of the NBI hardware is installed in the NB Cell, and this is outside the scope of the TAC Contracts. *However, the installation of the components that extend from the VV to the NB cell - the specialised NBI port structures, their internals and shielding - is TAC Contract scope.*

3.3.1.7.2 RF Systems

The EC H&CD System provides electron cyclotron microwave frequency power for plasma heating and current drive, control of instabilities via localized current drive, wall conditioning, and RF-assisted breakdown for plasma initiation. The IC H&CD System provides ion cyclotron radio frequency power for plasma heating, current drive, control of sawteeth activity, and wall cleaning.

The EC and IC systems (antennae) are integrated into the Tokamak as dedicated port plugs at the equatorial and upper port levels.

Figure 11 shows the arrangement of a typical IC antenna integrated into an equatorial port plug.

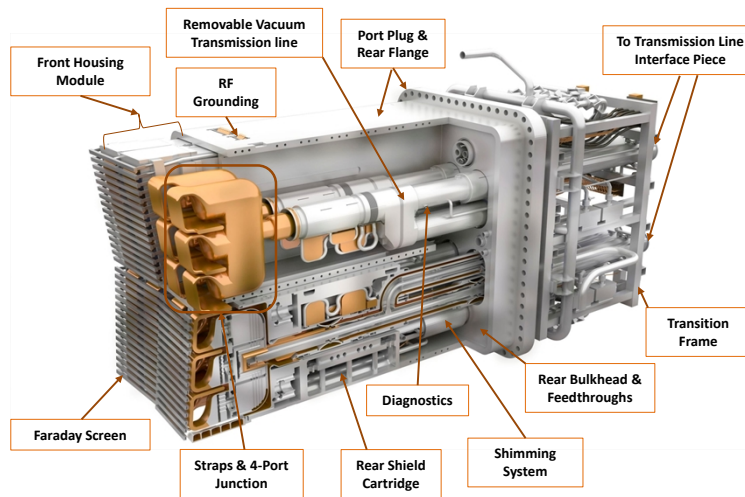

Figure 11. IC system antenna

The installation of the port plugs, or blanking plates to seal empty ports, is TAC Contract scope, and the currently planned total occupation at the end of the first two assembly phases, see section 3.1.1, is given in Table 4. Noting that there are a total of 18 upper (UPR), 14 equatorial (EQ) and 3 Lower (LWR) ports capable of hosting port plugs, the installation of blanking plates will be a major activity for Phase 1.

The installation of the plug based systems planned for Phase 1, see Table 4, is TAC Contract scope.

Plug Based System	Assembly Phase 1			Assembly Phase 2		
	UPR	EQ	LWR	UPR	EQ	LWR
Diagnostics		2		13	6	1
EC Heating	1			3	1	
IC Heating						

Table 4: Total Port Plug Occupancy at End of First Two Assembly Phases

3.3.2 Service and Other Systems

3.3.2.1 Tokamak Cooling Water System

The Tokamak Cooling Water System (TCWS) removes the heat from the in-vessel components and VV, and transfers it to the Component Cooling Water System (CCWS-1) and Chilled Water System (CHWS); it comprises three sub-systems:

- The VV-Primary Heat Transfer System (PHTS) - total capacity 32 MW - provides cooling for the VV;
- The Integrated loop of Blanket, ELM-VS, and Divertor (IBED)-PHTS – total capacity 880 MW - provides cooling for the following main clients:
 - Blanket Modules (FW panels and SBs),
 - Divertor Cassettes,
 - In-vessel coils (VS and ELM coils),
 - Diagnostic systems;
- The Draining and Refilling (DR) system provides the VV safety draining function in addition to normal TCWS draining.

All of the in-cryostat pipework is categorised ESPN Class N2 or Class N3, and is constructed in stainless steel 304L in accordance with ASME 31.3. The pipe runs are either double walled, or part of a bundle with a common containment that is subject to the same categorisation.

The in-cryostat TCWS can be divided geographically into a *lower part*, an *upper part*, and an *intermediate portion of the IBED-PHTS* serving mainly the divertor cassettes, as shown in Figure 12.

All three sub-systems are routed in the *lower part*, and extend radially from the Lower Pipe Chase (LPC) at building level B2M through penetrations in the bioshield, and vertically via feedthroughs into the cryostat, with an eighteen-fold segmentation. The IBED-PHTS in this *part* includes the inlet and return lines serving the equatorial ports, while only the inlet lines to the VV are routed for the VV-PHTS. The DR system follows a similar routing from the LPC to VV, but with a nine-fold segmentation (one drain line per VV sector).

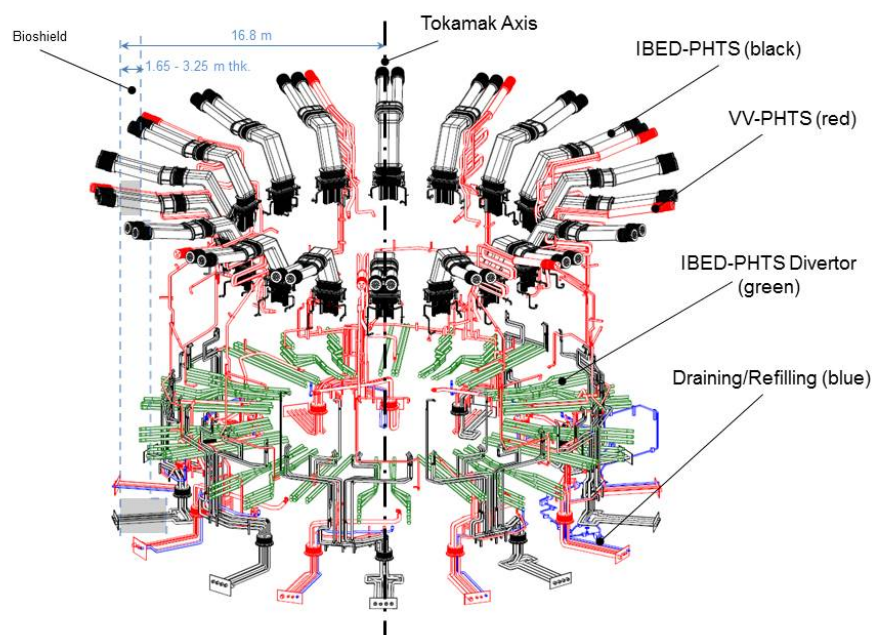

Figure 12: In-Bioshield Tokamak Cooling Water System

In the *upper part* both the VV-PHTS and IBED-PHTS subsystems are routed. The VV-PHTS in this *part* includes the return lines from the VV components; these lines are routed radially from the cryostat to the Upper Pipe Chase (UPC) at building level L3 in nine double-walled, groups via feedthroughs in the cryostat wall and penetrations in the bioshield. The IBED-PHTS inlet and return lines serving the BMs (FW/SB), and the ELM and VS coils are routed between the UPC and cryostat in the upper part, with the eighteen shrouded bundles routed via the bioshield and cryostat to the upper VV ports.

The inlet and return lines of the *intermediate portion* of the IBED-PHTS are routed from the LPC to building level B1, where it serves the divertor cassettes, lower VS coil, and other clients, via eighteen vertical shafts. This *portion* of the IBED-PHTS is routed through the cryostat to the VV via dedicated penetrations adjacent to, or integrated into the port structures.

3.3.2.2 Vacuum System

The Vacuum System pumps the vacuum volumes of the Torus and Cryostat to establish and maintain the required vacuum conditions, provides controlled venting and purging of these volumes, routes all potentially Tritium contaminated pumped gases to the Tritium Plant, and enables timely leak testing and leak localization of each of the volumes.

There are two Vacuum Cryopumping systems:

- The Torus Vacuum Cryopumping System, that is used during plasma operations to pump the Torus plasma exhaust, and provides high vacuum pumping during all other phases of machine operation. The Torus Vacuum Cryopumping system comprises six Torus Cryopumps (TCP);
- The Cryostat Vacuum Cryopumping System, that transiently evacuates the cryostat vessel to the pressure needed to cool the magnet and thermal shield systems to their cryogenic operating temperatures, and then operates in steady state to pump helium, hydrogen and air resulting from system leaks and component outgassing. The Cryostat Vacuum Cryopumping system comprises two Cryostat Cryopumps (CCP).

Located in the divertor level penetrations and port cells, the typical arrangement of a single Torus Cryopumping system is shown in Figure 13.

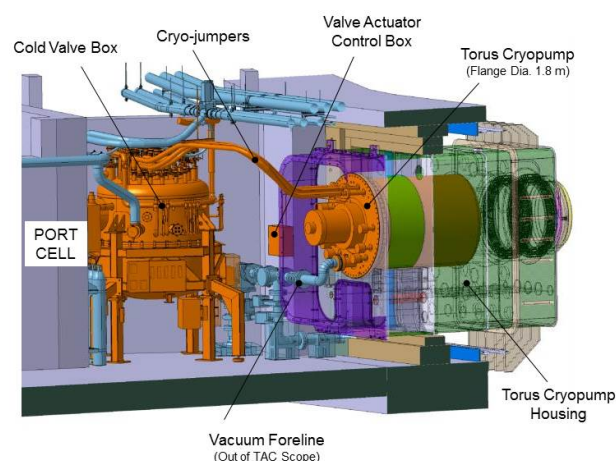

Figure 13: Torus Vacuum Cryopump System arrangement

The system comprises; one batch regenerating TCP, located in a cryostat wall mounted Torus Cryopump Housing (TCPH) – TCPH installation in the cryostat penetration is also Phase 1 TAC scope; a dedicated Cold Valve Box (CVB), providing cryogenic supply and return for operation of the TCP; flexible, Johnston type, Cryo-jumpers connecting the TCP to the CVB; and a cryopump Valve Actuator Control Box (VACB), located adjacent to the TCP and containing the electrical and pneumatic components to control the actuator of the pump.

The Cryostat Vacuum Cryopumping system has a similar arrangement; the main difference being that the CCP is mounted directly on a mating flange on the cryostat wall rather than to a TCPH.

The installation of the six TCPH, six TCP and two CCP is TAC Contract scope to be completed during assembly Phase 1.

3.3.2.3 Cable Trays and Instrumentation

In addition to the diagnostic sensors and cabling described in section 3.3.1.6, each of the major Tokamak systems is instrumented to facilitate component performance monitoring and protection.

For the four major systems - VV, Superconducting Magnets, VVTS and Cryostat - a total of 1600 temperature sensors, 800 strain gauges, 350 displacement sensors and 200 accelerometers are currently foreseen.

The majority of the sensors, and all of the associated cables and cable trays, cable connectors (patch panels), and the vacuum feedthroughs located at the vacuum boundaries will be installed on-site by the TAC Contractors during Phase 1 assembly.

3.3.2.4 Fuelling and Wall Conditioning Systems

The fuelling and wall commissioning systems comprise the Gas Introduction System (GIS), Pellet Injection System (PIS), Glow Discharge Cleaning system (GDC), and Disruption Mitigation System (DMS).

Glow discharge cleaning and gas introduction functionalities are respectively pre-requisite and essential for plasma operation, and as the permanent systems will be installed in assembly Phase 2, temporary systems will be installed in assembly Phase 1 to support First Plasma operation. The temporary GDC system comprises 9 electrodes, the associated cables and vacuum feedthroughs. The temporary GIS consists of pipework routed through the vacuum boundary and VV ports to the main VV chamber.

The PIS is not required for First Plasma operation, but the pipework and valves routed below the TCPH, see section 3.3.2.2, are captive components, and must be installed in assembly Phase 1.

4 Assembly Process

The overall assembly process is illustrated at the highest level in Figure 14, with assembly Phase 1 sub-divided into six groups of assembly activities (sequences). The following commentary relates to Figure 14.

The Tokamak is assembled from nine sectors, each encompassing a toroidal angle of 40°, and comprising a 40° VV sector, two TF Coils, a 40° VV Thermal Shield sector, and the associated interconnections and supports. The components are delivered to the site individually, and sub-assembled into sectors using purpose-built jigs and fixtures in the Assembly Building (*Assembly Sequence A2*).

Prior to the sector installation in the Tokamak pit, the gravity supports, lower cryostat sections, and the components which cannot be installed following final assembly of the sectors, principally the lower poloidal field coils, lower correction coils, the lower and side correction coil feeders, and the lower pre-compression rings, are installed or temporarily stored within the cryostat base (*Assembly Sequence A1*). In parallel, components of the feeders for the superconducting magnets are installed in the lower level gallery of the Tokamak Building.

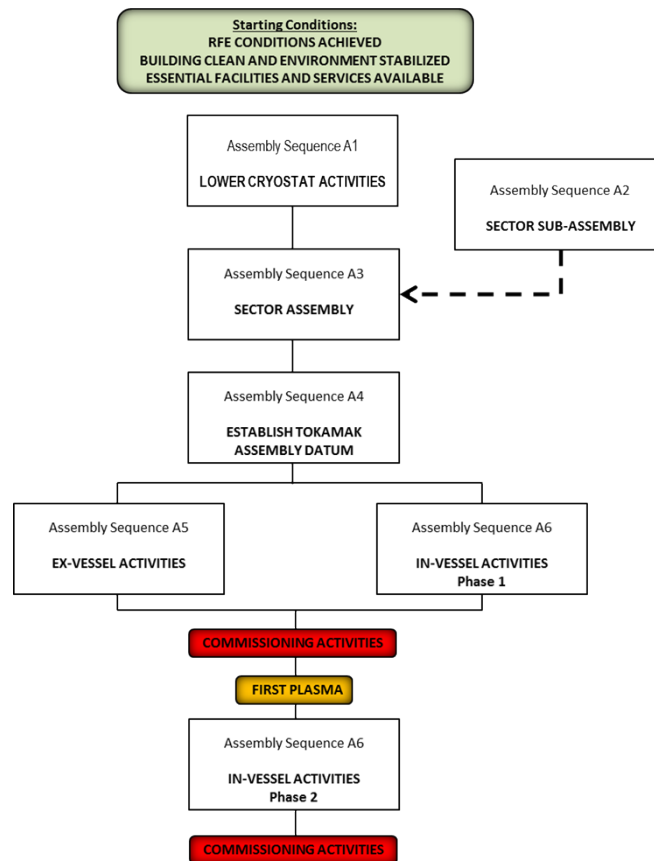

Figure 14: Tokamak Assembly Process

The sectors are then transferred to the pit sequentially where, following alignment, the TFC's are attached to their permanent supports and connected sequentially, the VVTS sectors are also connected sequentially, whereas the VV sectors are joined (welded) according to a plan which aims to minimise deformations, and the associated technical risk. Following installation of the final sector the VV is closed toroidally with the simultaneous welding of three, toroidally equi-spaced field joints (*Assembly Sequence A3*)

The permanent VV Gravity Supports are positioned, and attached to the VV and Cryostat. The TFC pre-compression rings are then installed, and the preload applied to each of the coils. A detailed dimensional survey at this stage provides the geometrical estimate of the magnetic datum for the as-built TF magnet, and this is used as reference for all subsequent alignment operations. The major Sector Assembly Tools are disengaged, and removed from the pit to allow the subsequent assembly sequences to proceed (*Assembly Sequence A4*).

Internal VV access is via selected horizontal ports at the lower (divertor) and equatorial levels. Clean conditions are established inside the vessel, and the installation of the Phase 1 in-vessel systems is completed (*Assembly Sequence A6*).

The completion of the installation of the ex-vessel components proceeds, with completion of the Cryostat in parallel (*Assembly Sequence A5*).

4.1 Assembly Facilities and Tools

To complete the assembly of the ITER Tokamak requires an extensive package of tools, and facilities in which to carry out the operations. The main assembly facilities are identified in section 3.

There shall be a clear demarcation between the tools supplied by IO, and those to be supplied by the TAC Contractors, and IO has initiated the procurement of the tools it will supply. In general these are the tools that are required early (first 18 months) in the assembly process, or have a particularly long lead time, and the resulting procurement schedule would be incompatible with the mobilisation of the TAC Contractors.

Where possible the TAC Contractors will participate in the design review process for the IO supplied tools, and for the longer term, each Contractor will be responsible for design and procurement of the tooling he will use.

5 Scope of the Contracts

5.1 Physical scope

Collectively, the scope of the Tokamak Assembly Contracts, see section 3.1.2, covers the mechanical assembly and installation and associated piping, electrical and instrumentation works to be completed during assembly Phase 1, with exceptions that will be executed under specific, dedicated contracts.

IO has estimated the total volume of work for Tokamak Assembly Phase 1 to be equivalent to ~3 Mio direct labour hours.

An overall duration of ~6 years is obtained for Phase 1, based on a 6 day, two shift working pattern yielding 90 productive hours per week, with radiography scheduled on night shift to align with, but to avoid interference with the assembly and installation works.

The Contractors will be required to sustain this pattern of working and shall have the resources available (and the necessary labour agreements in place) to expedite the recovery of schedule delays via additional shifts, including Sundays, should IO so require.

5.2 Scope Boundaries

The physical boundary of the Tokamak is, for the purpose of assembly and installation works, defined by the outer surface of the bioshield. In general terms, this surface demarcates the Tokamak Assembly Works to be executed by the TAC Contractors from the Tokamak Complex works to be executed by others.

Although there are numerous exceptions, where specific arrangements will apply, for systems and services crossing the scope boundary the interface between the TAC scope and that of the Tokamak Complex Contractors (TCC) shall be close to the outer surface of the bioshield, with the TAC hardware protruding outward across the boundary.

5.3 Scope of Work

In terms of Scope of Work, the scope will generally consist of the preparation, execution, control and documentation of the permanent works, plus any temporary works required to achieve the permanent works.

The site works will be executed under the management of the Construction Management as Agent (CMA), and IO has appointed MOMENTUM SNC as CMA for the Construction Project.

The Scope of Works of this Contract includes:

- development of Installation Work Packages (IWPs) from the documentation provided by IO and the CMA;
- identification, definition and provision of any required temporary works required to complete the permanent works, such as HVAC, lighting, protection, temporary access, safety equipment, standard tooling, etc.;
- design, procurement and maintenance of purpose-built tooling, including the maintenance of IO supplied tooling;
- provision of offsite, precision machining facilities; custom machining of IO supplied components;
- provision of all consumables and accessories required to complete the works;
- execution of the permanent works on site in accordance with the Project schedule;
- performance, and documentation of all required installation tests and verifications;
- preparation and issue of detailed as-built drawings, specifying dimensions achieved.

The Contractor's personnel shall have access to the ITER facilities as allowed by the IO.

6 Required Competences

The tokamak fusion reactor system integrates a uniquely extensive variety of high technologies in its design, that include: ultra-high vacuum, superconductivity, cryogenics, advanced cooling technologies for high heat flux components, low-z (beryllium) plasma facing components, high-z (tungsten) plasma facing component, etc. The ITER Tokamak adds further challenges such as massive, heavy components to be handled through environments with small clearances, and positioned with millimetre accuracy, in addition to being the first nuclear fusion device to be constructed as a Nuclear Installation.

The competence and experience of the TAC Contractors, and the ability, experience, and training of their engineering and construction team will have a direct influence on quality, re-work, and schedule, and ultimately on the performance of the Tokamak during operation; the Contractors will be required to demonstrate competence and experience in a number of key areas.

Core competences are those areas of technical experience that must be provided by the TAC Contractors or, in the case of Consortia, the Consortium members; these are identified in Table 5, below. The remaining competencies may be obtained by sub-contracting subject to the limit specified in the Procurement Summary document, in which case the TAC Contractors or Consortia will be required to identify SQEP staff members for the area of competence sub-contracted to guarantee adequate technical supervision.

Section	Area of Competence	Core Competence
6.1	Assembly Tooling	√
6.2	Clean Conditions Working	√
6.3	Codes and Standards	√
6.4	High Vacuum and UHV	√
6.5	Occupational Safety	√
6.6	Precision Assembly of Large and Complex Mechanical Systems	√
6.7	Process Development and Qualification	√
6.8	Quality Assurance / Quality Control	√
6.9	Regulated Construction	√
6.10	Welding	√
6.11	Clean Conditions Scaffolding	
6.12	Cleaning	
6.13	Inspection and Non-Destructive Examination	√
6.14	Instrumentation Installation	
6.15	Large Volume Optical Metrology	√
6.16	Lifting and Handling	√
6.17	Reverse Engineering, Customisation and Precision Machining, Workshop	
6.18	Tooling Maintenance, Storage and Preservation	

Table 5. Required Competencies and Experience

6.1 Assembly Tooling

The TAC Contractors shall assemble, commission (facilitating load testing and certification as required), operate and maintain, see section 4.1, the tooling supplied by IO for Tokamak Assembly. On-site technical support will be provided by IO during assembly and commissioning of these tools, as will documentation (manuals) covering the operation and maintenance of the tools.

The TAC Contractors will design, procure and commission assembly tools as described in section 4.1.

Experience in the design, manufacture, commissioning, testing, certification, operation and maintenance of large, precise, high-capacity tools, jigs and fixtures is required.

Furthermore, the Contractors will be required to complete all design activities within the scope of the TAC Contracts in accordance with IOs CAD processes, procedures and rules including those concerning data management and exchange, CAD quality and software.

6.2 Clean Conditions Working

The VV and Cryostat are classified UHV and High Vacuum respectively, as are all of the components and systems contained within each volume. Establishing and maintaining cleanliness and controlling debris and foreign objects is vital for machine performance and

reliability. As the Tokamak is not designed to be systematically cleaned at the end of assembly, strict control must be implemented throughout the assembly cycle to ensure contaminants do not accumulate, and the Tokamak and Assembly buildings will be operated under ISO Class 9 Cleanroom Standards.

Experience in clean assembly works, and in the strict control of personnel and equipment is required.

6.3 Codes and Standards

The systems that comprise the Tokamak have significantly varied functions, operating conditions, safety classifications, quality classifications, integrate a wide range of technologies, and the hardware is being sourced among all of the ITER Parties. A number of Codes and Standards apply to the design and fabrication of the Tokamak systems, including RCC-MR and ASME Section III for the Vacuum Vessel, ASME Section VIII Division 2 for the Cryostat, ASME B31.3 for Pipework, and custom codes for the Magnet System and Thermal Shields.

Accordingly, experience in the practical application of a broad range of codes and standards, to site construction activities, is required.

6.4 High Vacuum and UHV

The achievement of the Ultra-High Vacuum (UHV) environment necessary for Plasma operation inside the VV, and the high vacuum environment that thermally isolates the superconducting magnets and other in-cryostat components operating at cryogenic temperatures inside the cryostat is fundamental to the successful operation of the Tokamak. Experience in the design, manufacture and assembly of large scale vacuum systems is an essential requirement. All site assembly works on vacuum components and piping, such as assembly welds, will be subject to vacuum leak test controls by the TAC Contractor implementing the work, and relevant experience is essential, see section 6.13.

6.5 Occupational Safety

The working environment of the Tokamak presents numerous occupational safety risks, which include; heavy lifting and handling, confined spaces, suffocating gasses, working at heights, hot work, industrial radiography, pressurised equipment and pressure testing, and co-activity. Maintaining safe working conditions in this environment shall be a key priority for IO and for the TAC Contractors.

The Construction Management-as-Agent (CMA) shall operate a work permit system, and shall co-ordinate work between contractors, but the TAC Contractors shall be responsible for performing and documenting risk assessments for each work package, augmented by point-of-work risk assessments.

A clear, uncompromising commitment to safety and excellent track record, demonstrating the practical and consistent application of best-practice principles to ensure a safe working culture is required.

6.6 Precision Assembly of Large and Complex Mechanical Systems

The scope of the Tokamak Assembly Contract is primarily the site construction of mechanical systems, and the tight tolerances and other requirements specified for the major components necessitate high precision work, and rigorous and robust quality control. A broad range of experience and skills is demanded, including; handling, installation and alignment of large, heavy, sensitive, high value components; precise fit-up for weldments and mechanical connections; piping installations; instrumentation installations; and small bore pipe fitting.

The workforce shall be qualified and experienced mechanical, electrical and instrumentation craftsmen.

6.7 Process Development and Qualification

Assembly of the first-of-a-kind will require tests and trials to develop and successfully qualify the specific procedures and processes.

Experience in the development and qualification of detailed, novel assembly processes and procedures is required.

6.8 Quality Assurance / Quality Control

Quality Organizations consistent with achieving and guaranteeing compliance with the demands that nuclear regulation and regulator surveillance imposes; ISO 9001:2008 accreditation of the Contractors' QA systems is required.

The TAC Contractors are responsible for controlling the quality of their work, and that of their sub-contractors. Certain work must be witnessed by a Notified Body. All work will be subject to assessment by IO or IO representatives, and Protection Important Activities or Safety Relevant work will be subject to ASN audit.

6.9 Regulated Construction

As ITER is classified as a nuclear facility (INB-174), and is subject to strict regulation of work and quality; the Project is under the jurisdiction of the Autorité de Sûreté Nucléaire (ASN).

Activities identified as Protection Important or Safety Relevant (French Order of 7 February 2012) will be subject to additional surveillance. Relevant experience is a requirement.

It is important to note that not all Tokamak Assembly activities will be Protection Important or Safety Relevant, and the level of surveillance for these activities will be as indicated by the Quality Classification System.

6.10 Welding

Welding is a key activity and the joining processes are a significant part of the Tokamak assembly work. Experience in the implementation of high quality welding processes, supported by rigorous quality control standards and compliance with numerous construction (pressure vessel) codes is required; the majority of the material will be stainless steels.

The main welding technologies envisaged for the TA works are:

- TIG/GTAW
Manual, mechanized, and narrow gap techniques;
- MIG/GMAW
Manual and mechanized;
- Orbital Welding
To include orbital lathes for weld preparation and rework;

Specialist Welding will include:

- Bore Welding
Bore welding may be required for certain installations;
- Small manual TIG/GTAW welds
For attaching instrumentation to the VV;
- Small Bore Orbital Welding (mechanized and manual)
For joining waveguides and feed-throughs to the cryostat or VV;

- Seal welding (lip / canopy)
This technique is used for sealing the larger penetrations into the VV and cryostat;
- Capacitor Discharge Stud Welding (CDSW)
For attaching cabling and diagnostics to the VV, and attaching thermal shield panels;
- Spot Welding
For crimping clips to cable;
- Micro-TIG
For terminating the electrical cabling to the diagnostics sensors – where a high quality copper-to-copper weld is required.

6.11 Clean Conditions Scaffolding

During the assembly process, temporary access will be required to all parts of the Tokamak; because of the limited space, clean conditions, and abundance of high value, sensitive components, scaffolding is a specialist activity. All such scaffolding is to be supplied and erected by the TAC Contractors.

Knowledge and experience of this environment, the demonstration of robust processes to manage operator skills, and the storage and control of clean conditions equipment is required.

6.12 Cleaning

The High Vacuum and UHV conditions required for operation of the Tokamak systems necessitates the achievement and maintenance of strict levels of cleanliness throughout the assembly process. The ITER facility integrates a dedicated cleaning facility, B17, where the largest of the components will be cleaned to UHV standards by the respective TAC Contractor. Cleanliness standards and cleaning processes will be specified by IO, which the TAC Contractors will be required to implement. Relevant experience is a requirement.

6.13 Inspection and Non-Destructive Examination

The TAC Contractors are responsible for performing and documenting the specified inspections and tests necessary to guarantee the quality of their work, and for qualifying all such processes and the operators performing the work. Relevant experience in the implementation of a range of standard NDE techniques is required, including:

- Vacuum Leak Testing;
- Visual Inspection;
- Ultrasonic Testing;
- Radiographic Testing;
- Dye-Penetrant Testing;
- Eddy Current Testing;
- Magnetic Particle Inspection.

Qualification of operators and techniques shall be in accordance with the relevant codes and harmonised standards, and will be performed by the Contractors as required.

6.14 Instrumentation Installation

Several thousand sensors are distributed over the VV, providing measurements essential for the operation of the machine. These are very high precision components that require delicate installation to ensure they are accurate, and have the durability to last the life of the machine.

Suitably Qualified and Experienced Personnel (SQEP) are required to perform this specialist work which includes the following:

- high precision mechanical fitting;
- precision small bore pipe fitting
- manual TIG welding;
- micro-TIG welding;
- small bore orbital welding
- Capacitor Discharge Stud Welding;
- strain gauge installation (resistance and fibre Bragg grating);
- small diameter Mineral Insulated (MI) cable installation (e.g. thermocouple installation);
- fibre splicing and connector termination;
- polyimide cable installation;
- large volume metrology.

6.15 Large Volume Optical Metrology

Large volume optical metrology is the only viable tool for controlling the dimensions of the Tokamak, and given the large dimensions of the Tokamak systems and tight alignment tolerances to be achieved, the system will have to be operated at the limit of its capabilities to deliver the required precision.

Survey work will comply with the ITER Metrology Handbook, and will be subject to verification and audit by IO.

Extensive experience of large volume optical metrology and knowledge of best practice techniques is required.

6.16 Lifting and Handling

The TAC Contractors will be responsible for planning the lifting and handling operations required to complete, and support the assembly of the Tokamak from component point of delivery (B17). The scope includes the development of lifting plans for, in particular, all the major components and assemblies, which include a number of lifts in the range of 1200 - 1500t (including lifting tools).

The TAC Contractors will supply riggers and banksmen experienced in heavy, complex lifting operations (IO will supply crane operators).

6.17 Reverse Engineering, Customisation and Precision Machining, Workshop

The customisation of interfaces will be necessary to accommodate assembly and manufacturing tolerances, particularly for the large components with precise alignment requirements.

The assembly schedule requires the customisation of significant numbers of components on short time-scales, and the TAC Contractors will be responsible for providing, or ensuring access to, adequate machining facilities to meet the schedule, as well as developing the technical requirements. The TAC Contractors will perform all the activities necessary for the customisation process, including:

- Dimensional control and reverse engineering;

- Analysis and presentation of data, provision of models and drawing to define the custom machining to be performed;
- Machining of parts;
- Cleaning of parts to UHV or other standards as required;
- Packing and logistics.

To support the assembly activities, the TAC Contractors will provide, or ensure access to, a suitable general workshop facility in close proximity to the site to enable the fabrication and modification of items such as fixtures and jigs, piping, racking, temporary covers, etc. This workshop will be staffed by competent technicians, and have an acceptable selection of hand tools, machine tools, and welding equipment. Part of this workshop will be segregated for instrument engineering.

Experience in reverse engineering and precision machining of custom parts is required.

6.18 Tooling Maintenance, Storage and Preservation

The TAC Contractors shall provide and operate facilities close to site for the maintenance and repair of IO and TAC Contractor tooling, and shall be responsible for the transport of the tooling between site and workshop.

Space shall also be provided for storage of tooling during the contract under conditions sufficient to guarantee the integrity and continued function of the tools. Relevant experience is required.

Call for Nominations for Tokamak Assembly Contracts TAC1
and TAC2

Annex 2

ITER Procurement Strategy for Assembly and Installation

Ref. ITER_D_UG4W5S v1.0

IDM UID UG4W5S
VERSION CREATED ON / VERSION / STATUS 14 Feb 2017 / 1.0 / Approved
EXTERNAL REFERENCE / VERSION

Report

ITER Procurement Strategy for Assembly and Installation

Endorsed by MAC-S4 Special Video Conference on 20 December 2016 Version 1.0 - 07 February 2017 for distribution

<i>Approval Process</i>			
	<i>Name</i>	<i>Action</i>	<i>Affiliation</i>
<i>Author</i>	Flament F.	14 Feb 2017:signed	IO/DG/RCO/FPD/PCD
<i>Co-Authors</i>			
<i>Reviewers</i>	Lee G.- S. Sriram K. R. Tada E.	14 Feb 2017:recommended 14 Feb 2017:recommended 15 Feb 2017:recommended	IO/DG/COO IO/DG/RCO/FPD IO/DG/RCO
<i>Approver</i>	Bigot B.	15 Feb 2017:approved	IO/DG
<i>Document Security: Internal Use RO: Flament Francoise</i>			
<i>Read Access</i>	LG: Director for FPD Directorate, GG: FAB (Financial Audit Board), GG: IO DG, DDGs, AD: Only-staff, AD: EMAB, AD: Auditors, AD: ITER Management Assessor, project administrator, RO		

Table of Contents

1	PURPOSE	4
2	SCOPE	4
3	INTRODUCTION	4
4	KEY CHALLENGES, CONTRACTUAL PRINCIPLES AND ASSUMPTIONS	4
4.1	KEY CHALLENGES	5
4.2	CONTRACTUAL PRINCIPLES	5
4.3	ASSUMPTIONS.....	5
5	TOKAMAK ASSEMBLY (WORKSITE 1)	7
5.1	SCOPE	7
5.2	PREFERRED CONTRACT OPTIONS	7
6	TOKAMAK COMPLEX (WORKSITE 2)	8
6.1	SCOPE	8
6.2	WORKSITE 2: PREFERRED OPTION	9
7	PLANT INSTALLATION IN BALANCE OF PLANT (WORKSITES 3 TO 5)	10
7.1	SCOPE	10
7.2	WORKSITES 3, 4, 5: PREFERRED OPTION	11
7.2.1	<i>Non-Nuclear Buildings Group 1</i>	11
7.2.2	<i>Cooling Towers Location</i>	11
7.2.3	<i>Non-Nuclear Buildings Group 2</i>	12
7.2.4	<i>Installation of Multi-Process Lines</i>	12
7.2.5	<i>Bus-bars and Switching Networks</i>	12
7.2.6	<i>Nuclear Buildings</i>	12
8	CONTRACTUAL ASPECTS	12
8.1	CONTRACT MODELS.....	12
8.2	PAYMENT SCHEME	13
8.3	TENDER PROCESS.....	14
8.4	TENDER/CONTRACT RISK MANAGEMENT	14

Executive Summary

This document summarizes the updated strategy of the ITER Organization (IO) for the procurement of the works related to the assembly and installation of the Tokamak Machine and Tokamak Complex, as well as Plant and Auxiliary Systems.

At the Nineteenth Meeting of the ITER Council (IC-19) in November 2016, the ITER Council approved the updated Overall Project Schedule (OPS) through to First Plasma by December 2025 and, following a Staged Approach, start of Deuterium-Tritium (DT) Operation by December 2035. In order to deliver “the best technically achievable schedule”, the IO, together with all the Domestic Agencies (DAs), has to consider all possible options to avoid potential delays or increased costs. This is the primary reason why the IO has studied an approach to optimize the assembly procurement strategy, in line with the updated schedule, based on Worksites and manageable Work Packages with time phasing, while carefully considering interfaces between the work scope of the different assembly procurement packages.

In order to enforce a harmonized way to address the contractual approach, the IO has established a list of main contractual principles to keep in mind while developing the procurement strategy for the assembly and installation contracts.

Then, a thorough analysis of the needs was conducted, including key challenges, from the timely supply of the in-kind components, on-time delivery, especially for the Building “Ready for Equipment” (RFE) milestones, up to final acceptance tests. Logically, it appeared that the best way to comply with the objectives of cost and schedule performance, and risk mitigation, was to orient the procurement strategy towards a phased approach and several contracts, for each worksite or group of worksites.

Regarding the Tokamak Machine Assembly (Worksite 1), it is proposed to split the scope of work into two contracts while minimizing the interferences between the two Contractors. Each of them will be dedicated to its own scope, until commissioning of the Tokamak (TKM).

As regards the Tokamak Complex (Worksite 2)¹, the assignment of phased long-term large contracts will facilitate the advance development and preparation of the Tokamak Complex works per system, location, sequence and phase. The oversight and advancement of the works will be closely managed by the IO through the Construction Management-as-Agent (CMA). It is also very important to harmonize the sequence of works in this Worksite with the EU-DA..

Lastly, the scope of Plant Installation in Balance of Plant (Worksites 3 to 5) has been divided into three major locations of installation and two additional dedicated contracts, considering the nature of the works, availability of the buildings according to the approved long-term schedule and system commissioning. The contracts for nuclear and non-nuclear buildings will be placed separately in order to better target the Contractors’ skills.

In order to minimize the number of contracts and ensure clear responsibility for performance, it is further proposed to cover the whole installation of the Bus-bars, Fast Discharge Unit (FDU) and Switching Network (Worksite 2 up to Worksite 5), and the works for Multi-process Lines (from Worksite 2 to Worksite 4).

Overall, the proposed strategy is in line with the resource-loaded schedule underpinning the OPS as approved at IC-19 and the staffing cap of 1 050 IO staff members approved by the IC. The

¹This excludes the Tokamak Machine Assembly.

strategy was thoroughly developed, involving CMA and DA Heads. The IO also benefitted from other large-scale project experiences such as the Large Hadron Collider (LHC) at the European Organization for Nuclear Research (CERN) in Switzerland.

The strategy is deemed to be robust. It has carefully considered the management of interfaces, and will allow better monitoring, resulting in a better schedule control and cost savings in the execution of the contracts.

Still, further work needs to be performed together with the DAs and the CMA in order to successfully implement this procurement strategy. For this reason, it is foreseen to launch as soon as necessary early Works Contracts so as not to delay the installation of captive components as soon as they are available.

Overall, nine main assembly and installation contracts are contemplated.

1 Purpose

This document summarizes the updated procurement strategy of the ITER Organization (IO) for the works related to the assembly and installation of the Tokamak Machine and Tokamak Complex, as well as Plant and Auxiliary Systems for Assembly Phase I in line with the Staged Approach.

2 Scope

The ITER Facility is a first-of-a-kind megaproject involving key technologies and complicated interfaces between systems and sub-systems. Moreover, ITER is a Basic Nuclear Installation (INB) that shall be constructed in accordance with the French Nuclear Laws and Regulations, as well as European Codes and Standards.

This document describes the new procurement strategy developed for the tender preparation, the award and the execution of all construction works to be performed by the IO. It excludes manufacture of the components and construction of the buildings.

3 Introduction

At the Nineteenth Meeting of the ITER Council (IC-19) in November 2016, the ITER Council approved the updated Level-0 Overall Project Schedule (OPS), underpinned by a resource-loaded Master Schedule, through to First Plasma by December 2025 and onward through a Staged Approach to the start of Deuterium-Tritium (DT) Operation by December 2035. In order to deliver “the best technically achievable schedule”, the IO, together with all the Domestic Agencies (DAs), has to consider any possible options for avoiding potential delays or increased costs, and also for minimizing risks. This is the reason why the IO has studied an approach to optimize the assembly procurement strategy, in line with the updated schedule, through a phased approach and several contracts, based on Worksites, locations and manageable work packages, while optimizing interfaces between the work scopes of the assembly and installation procurement packages.

4 Key Challenges, Contractual Principles and Assumptions

The ITER Project supply chain is complex, with in-kind deliveries of components shipped from around the world and no direct contractual relationship between the IO and the DAs’ manufacturers. Uncertainties will remain in the delivery schedule of components and the building “Ready for Equipment” milestones due to technical and other risks in manufacturing and construction, although the IO under the DG’s leadership and all the DAs will continue to work together to minimize such uncertainties in delivery dates, and will follow an aggressive risk mitigation approach. Furthermore, there will inevitably be non-conformities and deviation requests which will require modifications or adjustment during assembly. The IO will need to be able to manage its works according to the DAs’ deliveries as well as its own existing contracts for the scope under its responsibility. On the other hand, the DAs will have to commit to the components being delivered on time in order to avoid any impact on the assembly schedule and sequences. This specificity necessitates maximum flexibility in the overall procurement strategy for the construction and a phased approach. This flexible and phased approach to assembly contracts is also consistent with the time-phased finalization of technical and design inputs required for assembly and installation activities, especially with the Tokamak Complex.

4.1 Key Challenges

Several key challenges have been identified and carefully considered while developing the procurement strategy. They are in link with the maturity of the design of identified components and systems, interface definition, tools, interactions with work scope for DAs, and schedule constraints.

4.2 Contractual Principles

In order to enforce a harmonized way of addressing the contractual approach, the IO established a list of main contractual principles to keep in mind while developing the procurement strategy for the assembly and installation contracts:

- Always think “Global ITER Site”;
- Strive for cost and schedule control and flexibility over the Construction Phase, through manageable sub-systems/lots, number of Contractors involved and distribution of contracts and strong risk management;
- Minimize interfaces and interferences within the work scope of different assembly and installation Contracts and Contractors;
- Secure execution of the work through temporary backup;
- Maintain industry know-how and knowledge of the Contractors throughout the Construction Phase;
- Allow industry to propose methods/processes/input within well-defined boundaries to get effective results.

These principles were shared and checked at each step of the development of the procurement strategy.

4.3 Assumptions

The main assumptions considered for the new approach were developed considering the overall complexity of the installation activities, maturity of the design and interface definition, and the schedule constraints:

- The contracts will all be phased, including a preparation period in order to:
 - take into account the learning curve of the IO, CMA and Works Contractors;
 - allow better preparation of the technical/tender packages, and thus minimize uncertainties and perceived risks which could result in high tender quotes;
 - secure the full speed of assembly operations (between 2020 and 2024).
- Manageable sub-systems at equivalent level of complexity and skills;
- IO direct management of special processes, carefully identified to be the minimum;
- Differentiate approaches to Nuclear and Non-Nuclear Buildings;
- Common tools and procurement under the IO’s responsibility: Lifting, Handling, Scaffolding, Cleaning, Building remedial works and finishing, etc.;
- Types of contract: FIDIC Red Book or service contracts according to the level of uncertainty in the definition of the deliverables and the time schedule;
- Distribution per Worksite, Building, group of Buildings or Location (see Figure 1).

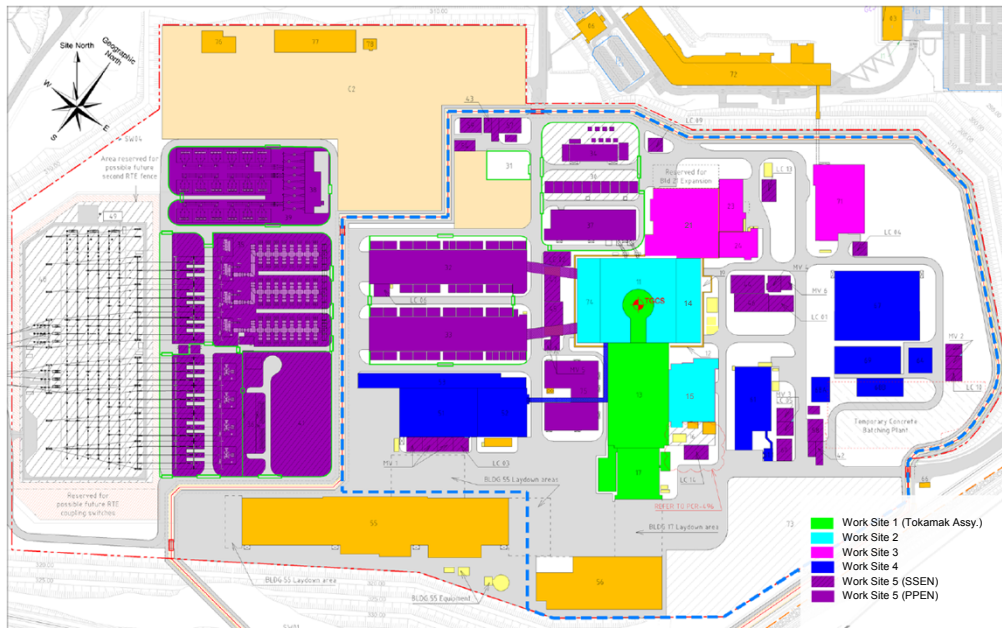

Figure 1: Distribution of the Worksites

The ITER site encompasses the entire location of the ITER Platform. During the execution of assembly and installation works, the Platform will be divided into five Worksites. Each of them will consist of a group of related buildings, access paths and laydown locations which will be isolated within a perimeter (physical or not). They will be based upon the requirements to:

- Identify locations which are to the greatest possible extent able to be physically isolated;
- Group together similar construction scope/disciplines;
- Minimize the management of interfaces between workers and work scope;
- Mitigate the potential for claims and disputes due to disruption.

This grouping of worksites is also consistent with the time-phasing of construction activities in accordance with the updated ITER Master Schedule based on the Staged Approach.

Further to the DG’s decision to create a Construction Organization, the functional organization of the construction activities within the IO is now based on three construction teams as follows (see Figure 2):

- Construction Team for Tokamak Assembly (CTTA), in charge of Worksite 1;
- Construction Team for the Tokamak Complex (CTTC), in charge of Worksite 2;
- Construction Team for Plant Installation (CTPI), in charge of Worksites 3, 4 and 5.

This will be supported by the Construction Department (CST) and the CMA.

It is agreed that interfaces between three construction teams are to be carefully addressed and that any physical system interfaces shall be analysed in order to find the best procurement approach.

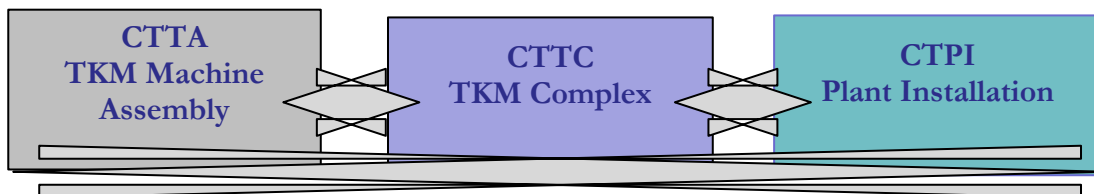

Figure 2: Construction Organization

Each Worksite Construction Team Leader is responsible for the preparation, surveillance and field engineering of construction works, in close collaboration with Engineering Departments, CST and CMA support.

5 Tokamak Assembly (Worksite 1)

The goal of developing the procurement strategy for the Tokamak Assembly (Worksite 1) was to achieve the most efficient contracting option for installation works. The final adopted approach needs to be in line with the contractual principles defined above, especially regarding installation continuity, knowledge retention, cost containment and risk mitigation. Furthermore, the final adopted strategy shall be consistent with the updated ITER Master Schedule to First Plasma.

5.1 Scope

Worksite 1 (see Figure 3) covers all assembly and installation activities related to the following Buildings:

- B11 (Tokamak Pit)
- B13 (Tokamak Assembly Hall)
- B17 (Cleaning Facility)

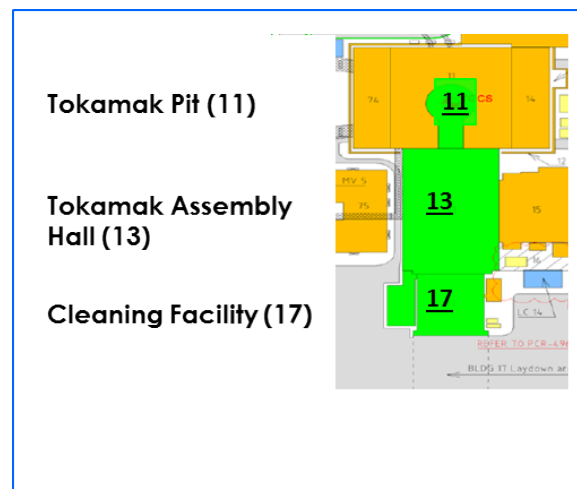

Figure 3: Worksite 1 Distribution

5.2 Preferred Contract Options

Intensive brainstorming sessions were conducted in order to find optimum solutions to phase and divide the massive amount of different assembly and installation activities spanning from Lower Cryostat Assembly (February 2018) to the final closure of the Cryostat (December 2024). It appeared that solutions should be driven in order to allow a better preparation of Construction Work Packages (CWPs) per phase. The oversight and surveillance of the whole assembly process is assured while having defined “discrete assembly lots”.

The preferred Option will consider splitting the work scope into two contracts. Although the two Contractors will be in charge of their own scope until Integrated Commissioning of the Tokamak, they will be qualified to cover all works and processes up to Assembly Phase II of the Staged Approach. The SOWs for the two contracts have been clearly outlined (with the possibility of subsequent minor changes, especially early works of small work packages) to minimize interference and interfaces, as below:

Contract 1: Activities A2/A3/A5-Side (except VVFJW placed with ENSA);

Contract 2: Activities A1/A5-Upper/A5-Lower/ A7, part of the Magnet Feeders Installation.

The detailed numbering and layout are shown in Annex 1.

A competition will be launched between both Contractors for in-vessel components assembly works and later works to be performed during Assembly Phase II.

Due to the uncertainties, especially regarding the delivery of the components, the strategy is deemed robust based on industry or individuals' experience and peer pressure that it enforces on the Contractors in the execution of the works.

The main technical criteria for using two contractors are linked to the clear split between the two work scopes:

- A2/A3/A5-S Work Package:
 - Mainly Vacuum Vessel and Port (mostly warm-component oriented)–related Assembly Activity;
 - Main and Sub-assembly Activity for complete torus;
 - ESPN and ANB related Activity: mainly thick Stainless Steel Welding and NDE inspection work, to comply with regulatory surveillance requirements under same responsible Contractor.

- A1/A5-Upper/A5-Lower/ A7, and Part of the Magnet Feeders Installation:
 - Cryostat and its associated Thermal Shield Installation Activity;
 - Major Magnet Feeders installation activity;
 - Relatively independent from ANB related Issues;
 - Pre-assembly Activity: physically separated from other contractor.

In addition, several other reasons were taken into account, such as:

- No major interface issues with existing Contractors (IN-DA – Cryostat Welding), (EU-DA – TB04) and IO Contractors (e.g. Vacuum Vessel Field Joint Welding);
- Better optimization of potential delays by covering more parallel works during peak work load period (2023-2024);
- Better management of delivery uncertainties from major components such as Vacuum Vessel and Toroidal Field Coils;
- Efficient control over all activities related to special processes (e.g., Magnet Joint Connection, Special Instrumentation in a cryogenic environment).

The installation sequences of the work between the two Contractors will be carefully managed together with the CTTA and CMA at a very early stage, assuring the appropriate coordination in the execution of the works.

6 Tokamak Complex (Worksite 2)

6.1 Scope

Worksite 2 (see Figure 4) covers all assembly and installation activities related to Buildings:

- Building 11/14/74 (Tokamak Complex);
- Building 15 (RF Heating Building) and Connections to the Tokamak Complex via B13.

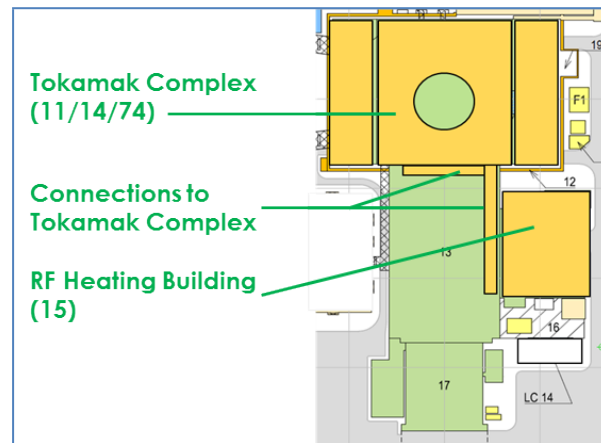

Figure 4: Worksite 2 Distribution

Installation activities on Worksite 2 are very complex due to the close interfaces with the Building and Building Services (especially for Plant Systems) and the progressive phased approach towards finalization of technical and design inputs in time for assembly and installation.

Construction Activities on Worksite 2 have been broken down in order to group similar skills following logical sub-divisions of works, systems and access constraints. The aim is to facilitate the management of interfaces and co-activity in this worksite which is particularly congested.

As for Worksite 2, the level of complexity of the Work Packages will be considered carefully in the contract to allow for better control over the schedule, cost and quality.

The goal of developing the procurement strategy for Worksite 2 was to explore and evaluate possible contract options associated with installation works in the Tokamak Complex and the RF Building (Buildings 11, 14, 15 and 74). The final adopted approach needs to provide continuity of installation sequence as well as cost containment and risk mitigation.

Extensive discussions and brainstorming sessions between the relevant IO Departments and experts were conducted over the course of many weeks. The sessions focused on optimizing the major works Contractor Management, especially in line with the sequencing, constructability, overall requirements and critical interfaces for the period from Q4 2018 to the completion in Q4 2024. The final adopted approach will take these issues into account by phasing in a logical and consistent manner.

The proposed contract strategy is to facilitate the advanced development and preparation of the Construction Work Packages per system, location, sequence and phase, and minimizing the scope for future changes in quantities and scope etc. The oversight and advancement of the installation activities throughout the whole process will be closely managed by the IO together with the CMA, while maintaining a clearly defined approach to construction by system and location in alignment with the updated ITER Master Schedule.

6.2 Worksite 2: Preferred Option

The preferred option relies on two multi-disciplinary Contracts with specific scope allocation by location. In addition, two dedicated contracts were identified for:

- a. Bus-bars & Fast Discharge Unit (FDU) / Switching Network scope in Worksites 2, and 3,4,5;
- b. Multi-process Lines scope in Worksites 2 and 3, 4, 5.

It is proposed to combine these two dedicated Contracts for Worksite 2, with the other part of the installation of the same components necessary for Worksites 3, 4, 5 (see Section 7). Then, the same Contractor will be in charge of the whole system.

This Option is designed to maintain backup solutions in case of the failure or poor performance of one of the Contractors, with relatively short contract periods of two to three years in duration limiting the issuance of large upfront contracts and extending the time available to develop matured technical specifications for each contract, and to enhance more competition within the execution of the contracts.

The two multi-disciplinary (Electrical and Mechanical) Contractors will execute their own scope until commissioning of the Tokamak Complex Systems, with subdivision of the works by systems and location. The installation sequence will dictate the access and specific system activities by taking into account the requirements to be detailed in association with the CMA in the near future.

First Multi-disciplinary Works Contractor Scope will comprise locations defined as follows:

- Heating and Current Drive Systems (ECH, ICH, and NBH)
- Diagnostic Systems
- Fueling system
- Component Cooling Water System (CCWS & CHWS)
- Phase one Tritium System
- Vacuum components in the specific locations
- Cubicles Installation
- Feeders components outside of CTTA scope
- Phase one activity of Building 74 and 14

Second Multi-disciplinary Works Contractor Scope will comprise Systems defined as follows:

- Tokamak Cooling Water Systems
- CCWS-1 (in Bldg. 14 valve room and DTR)
- Test Blanket Modules pipes
- Vacuum pipework in the specific locations
- Phase one VVPSS

This approach is intended to provide a balance of complexity, skills and scope. In addition, Option 3 could maintain and guarantee the system integrity and provide management of all ESPN requirements by having works performed by a single Contractor, simplifying the tender process by providing a more mature Technical Specification, while maintaining competitive peer pressure throughout the duration of the contracts.

7 Plant Installation in Balance of Plant (Worksites 3 to 5)

7.1 Scope

Worksites 3 to 5 (see Figure 5) include:

- Worksite 3: Control Buildings and Access Control Building;
- Worksite 4: Cryogenic Plant, Cooling Station and Site Services Buildings;
- Worksite 5: Electrical and Power Supply Buildings.

They cover all Auxiliary Buildings as well as distribution through bridges or steel frames in the Plant Yard, which are considered comparatively independent activities and working with their engineering organization.

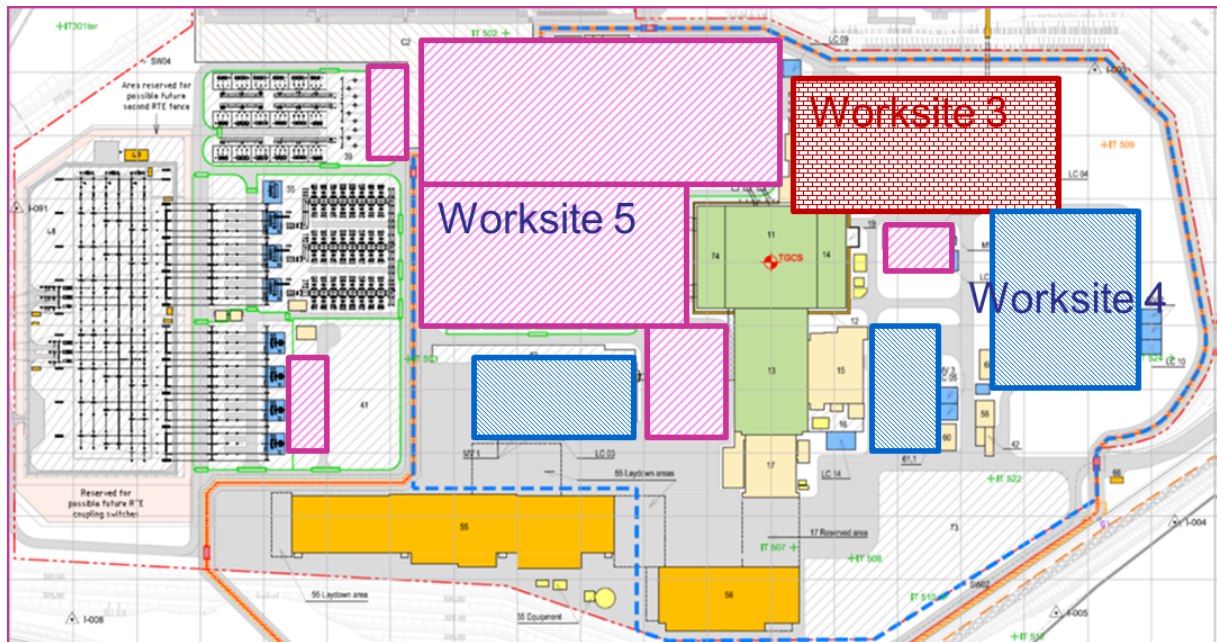

Figure 5: Worksites 3, 4, 5 Distribution

7.2 Worksites 3, 4, 5: Preferred Option

Primary objectives in selecting the most effective installation strategy in the Balance of Plant (BoP) of ITER Project are the following:

Separate Nuclear and Non-Nuclear Buildings in order to get more flexibility and cost savings:

- Assign the contracts per building, group of building or Worksite covering mechanical and electrical scopes together;
- Multiple contracts with limited duration in time for each contract (3 to 4 years);
- No conflict of interest between locations of work;
- Keep common tools under the IO's responsibility (Lifting, Handling, Procurement of Cables).

According to the above objectives, the organization of the Construction Site for BoP is split in major different locations of installation according to the approved long-term time schedule, availability of the buildings and systems commissioning (the detailed numbering of the buildings is shown in Annex 2):

7.2.1 Non-Nuclear Buildings Group 1

The Non-Nuclear Building Group 1 covers:

- Building 32: Magnet Power Conversion
- Building 33: Magnet Power Conversion
- Building 36: Main Alternating Current Distribution
- Building 38: Reactive Power Control

7.2.2 Cooling Towers Location

This includes the following buildings:

- Buildings 51-52: Cooling Water, Electrical and I&C associated with the Cryoplant under IO scope
- Building 64: HRS Water Treatment Facility
- Building 67: Cooling Towers
- Building 68: Pumping Station
- Building 69: Heat Exchangers location

7.2.3 Non-Nuclear Buildings Group 2

The Non-Nuclear Buildings Group 2 covers:

- Building 75: Fast Discharge and Switch Network Resistor
- Buildings 34-37: Neutral Beam Power Building
- Building 71: Control Building
- Buildings 44-47: Emergency Power Supply

7.2.4 Installation of Multi-Process Lines

Due to the specific skills necessary for this scope, the contract will be awarded to a specialist in Multi-process Lines, working in the following locations:

- Building 51-52: Multi-Process Lines
- Bridge between B51 – B11 (Multi-process Pipes and CGVS Units in bridge)
- Building 11: Cryolines up to Feeder Connections

7.2.5 Bus-bars and Switching Networks

As mentioned in Section 6.3, this Contract will include the Bus-bars, FDUs and Switching Network units for both Buildings 74 and 11 (Tokamak Complex), up to Buildings 32/33, with the goal of having the complete Bus-bar distribution installed by the same dedicated Contractor.

7.2.6 Nuclear Buildings

As regards the Nuclear Buildings and associated plant installation to be performed at Worksites 3, 4 and 5 none of these are required to be operational by First Plasma. Hence, this scope of work is excluded from the set of contracts for First Plasma. The Buildings to be completed at a later stage are listed below:

- Building 21: Hot Cell
- Building 23: Radwaste System
- Building 24: Access Control
- Building 25: Fuel Cycle Cylinder Gases Compound
- Buildings 42-43: Fuel Storage Tanks
- Buildings 57-58: SIC Generator System
- Buildings 59-60: IP Generator System

8 Contractual Aspects

In accordance with the operational needs and contract principles developed in Section 4 of this document, several types of contract and payment schemes have been studied.

8.1 Contract Models

The selection of a contract shall meet the demands of the project and reflect the aspirations of the contracting parties. Therefore, it is essential to consider key criteria and risk allocation before the form of contract is selected. The choice of contract flows from the balance of time/cost/quality and how that can be achieved, as well as the level of maturity of the design, and the risk sharing.

All these points are directly linked to the likelihood of changes (or variations) while assembly and installation are taking place.

The proposed selection has been made from a range of standard FIDIC forms of contract, as well as considering types of service contract.

The best suitable models for assembly and installation were identified as follows, knowing that the IO takes full responsibility for the design, and that the risk sharing decreases for the Contractor depending on the complexity in the execution of the project:

- FIDIC Red Book/Construction: the Contractor constructs the works in accordance with design details provided by the “Employer” (IO) or its representative, the “Engineer” (CMA). However, it allows the Contractor to be requested to design part of the electrical, mechanical and/or construction works, particularly related to site-specific aspects.
- Service contracts: the most suitable solution whenever the scope and the schedule could be subject to a high level of uncertainty.

For all worksites, it is proposed to base the activities on a consistent breakdown of works throughout the release of Work Packages. Depending upon the level of certainty of the design and delivery by the DAs of the in-kind components, the first works could be released on a firm-price basis whenever the scope and schedule are sufficiently mature. Then Technical Specifications and drawings can be established and confirmed for the following years on a rolling-wave approach. Once technical inputs are ready, and not less than three to six months before the works start, the CMA will manage the instruction of works and the associated cost, schedule and the coordination between Contractors.

Key Performance Indicators (KPIs) will be associated with each Work Package for assessing Contractors’ performance (safety, quality, completion of works, documentation, as-built drawings, etc.).

8.2 Payment Scheme

The payment scheme is directly linked to the level of uncertainty in the design and/or the schedule.

The more uncertain the activities or schedule will be, the more flexibility the contract should have in order to accommodate changes without Contractor claims for increased costs (see Figure 6). Various criteria will be taken into account in order to decide on a case-by-case basis amongst the following payment models:

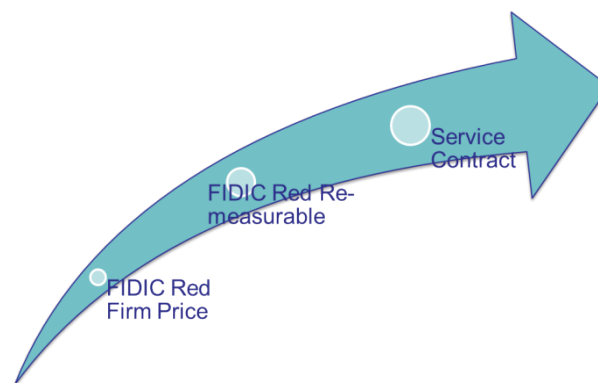

Figure 6: Types of Contract with regard to Complexity

- Lump-sum Basis: may be suitable if the tender documents include technical and schedule details which are sufficiently complete for the construction and where variations are unlikely;
- Re-measurement: the contract value is based on estimated quantities but the Contractor is obliged to carry out all the work which is required by the Specification and Drawings, and is paid for the actual quantities of work which it has executed (Article 12 FIDIC Red Book).
- Service Contract: IO type of contract, enabling the use of a variety of procurement methods, such as:
 - Priced contract with activity schedule
 - Priced contract with bill of quantities
 - Target contract with activity schedule
 - Target contract with bill of quantities
 - Cost-reimbursable contract, mainly for equipment

8.3 Tender Process

Tenders need to be prepared to a good quality; it is particularly important to take into consideration the Tenderers' perspective by:

- Defining the scope very clearly in the Technical Specification and nowhere else;
- Making the documents as simple and easy to comprehend as possible:
 - Keeping the amount of technical information in the Tender documents to the minimum necessary for Tenderers to have all they need to submit their Tender and no more;
 - Specifications should clearly and concisely define the Scope of Works in a logical sequence;
 - Avoiding ambiguities, repetition and contradictions: all information for each topic to be in only one document and in one clause in that document.
- Defining all the Conditions of Contract in that section and nowhere else;
- Using standard FIDIC models and terminology, in the case of FIDIC types.

As much as possible, the IO will encourage thorough peer review at each step of the tender process before issue.

8.4 Tender/Contract Risk Management

First Plasma will not be delivered by one organization alone. That is why the increased focus on delivery emphasizes the need for effective relationships. Therefore, as mentioned earlier, it is paramount to have an accurate and efficient risk analysis in order to establish a successful partnership that will be able to deliver. It is also necessary to ensure that risks are shared by the parties (IO or Contractor) best placed to control such risks. For example, risks on account of delayed deliveries have to be borne by the IO and not the Works Contractors; that is precisely why the contracting strategy has been refined to ensure that these risks are not borne by the Works Contractors.

For this reason risk assessment and mitigation actions are to be developed from a contractual point of view and for each stage of the process: technical requirements, tender package, as well as for contract execution. It also includes the DAs' delivery schedules and work complexity at CWP level.

Therefore, there is important work ahead, and key features have been identified for development in the near future.

Annex 1

Worksite: Layout and Assembly Lots

- A1: Lower Cryostat in Pit
- A2: Sector Sub-Assembly
- A3: Sector Assembly in Pit
- A4: Metrology
- A5-S: Ex-Vessel Side
- A5-U: Ex-Vessel Upper
- A5-L: Ex-Vessel Lower
- A6: In-Vessel for only First Plasma
- A7: Pre-Assemblies (Central Solenoid (CS), Lower Cryostat Thermal Shield (LC-TS), Upper Cryostat Thermal Shield (UC-TS))

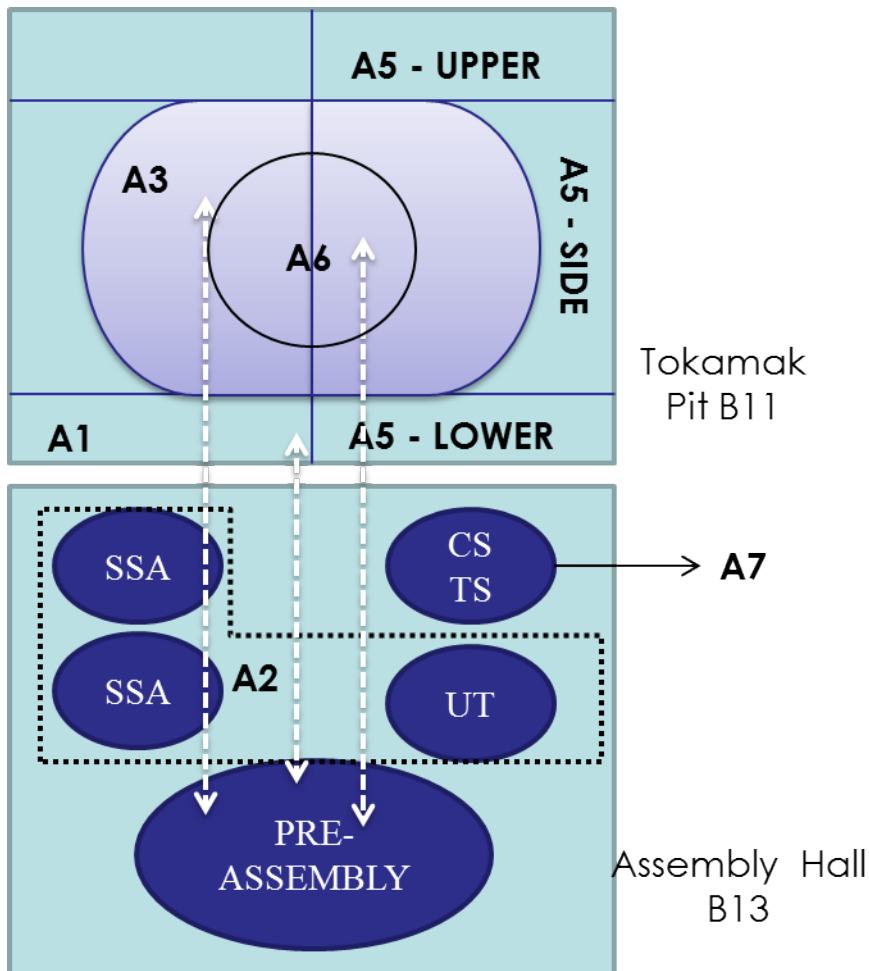

Annex 2 Buildings Layout

